

Specifications

General Specifications

Specification	acA1920-155uc
Resolution (H x V Pixels)	1936 x 1216 (full resolution) 1920 x 1200 (default resolution) You can change the resolution by changing the Image ROI .
Sensor Type	Sony IMX174LQJ-C Progressive scan CMOS Global shutter
Optical Size	1/1.2"
Effective Sensor Diagonal	13.4 mm
Pixel Size (H x V)	5.86 μm x 5.86 μm
Frame Rate (at Default Settings)	164 fps
Product Line	ace U
Mono / Color	Color
Image Data Interface	USB 3.0, nominal max. 5 Gbit/s (SuperSpeed)
Pixel Formats	See Pixel Format .
Synchronization	Via hardware trigger Via software trigger Via free run
Exposure Time Control	Via hardware trigger Programmable via the camera API
Camera Power Requirements	Nominal 5 VDC supplied via the camera's USB 3.0 port ≈ 3.4 W (typical) @ 5 VDC ≈ 3.7 W (max.)

I/O Lines	1 opto-coupled input line 1 opto-coupled output line 2 general purpose I/O (GPIO) lines
Lens Mount	C-mount
Size (L x W x H)	29.3 mm x 29 mm x 29 mm (without lens mount or connectors) 48.2 mm x 29 mm x 29 mm (with lens mount and connectors)
Weight	<80 g
Conformity	CE (includes RoHS), UL Listed, FCC, GenICam 2.x (including PFNC 2.x and SFNC 2.x), IP30, USB3 Vision, REACH The EU Declaration of Conformity is available on the Basler website .
Software	Basler pylon Camera Software Suite (version 4.0 or higher) Available for Windows, Linux x86, Linux ARM, and OS X
Accessories	Cables for your camera model Lenses for your camera model Additional accessories for your camera model

Spectral Response

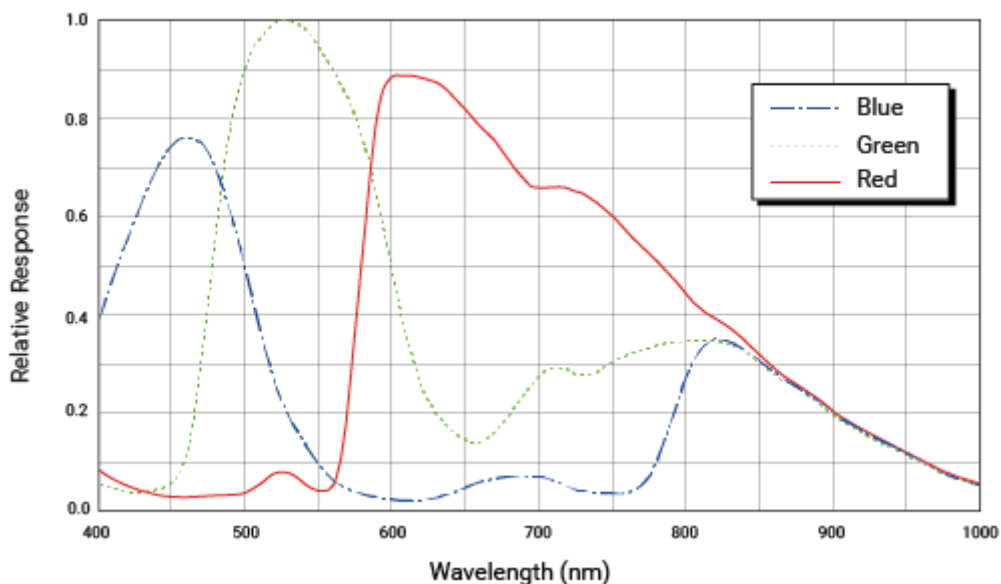

The spectral response curve excludes lens characteristics, light source characteristics, and IR cut filter characteristics.

IR Cut Filter

Color cameras are equipped with an IR cut filter. The filter is mounted in a filter holder inside the lens mount.

The IR cut filter has the following spectral characteristics:

Wavelength [nm]	Transmittance
450–610	$T_{\min} > 90 \%$
450–620	$T_{\text{avg}} > 93 \%$
645 ± 10	$T = 50 \%$
700–1070	$T_{\max} < 4 \%$
690–1070	$T_{\text{avg}} < 1 \%$

The filter holder can't be removed.

Mechanical Specifications

Camera Dimensions and Mounting Points

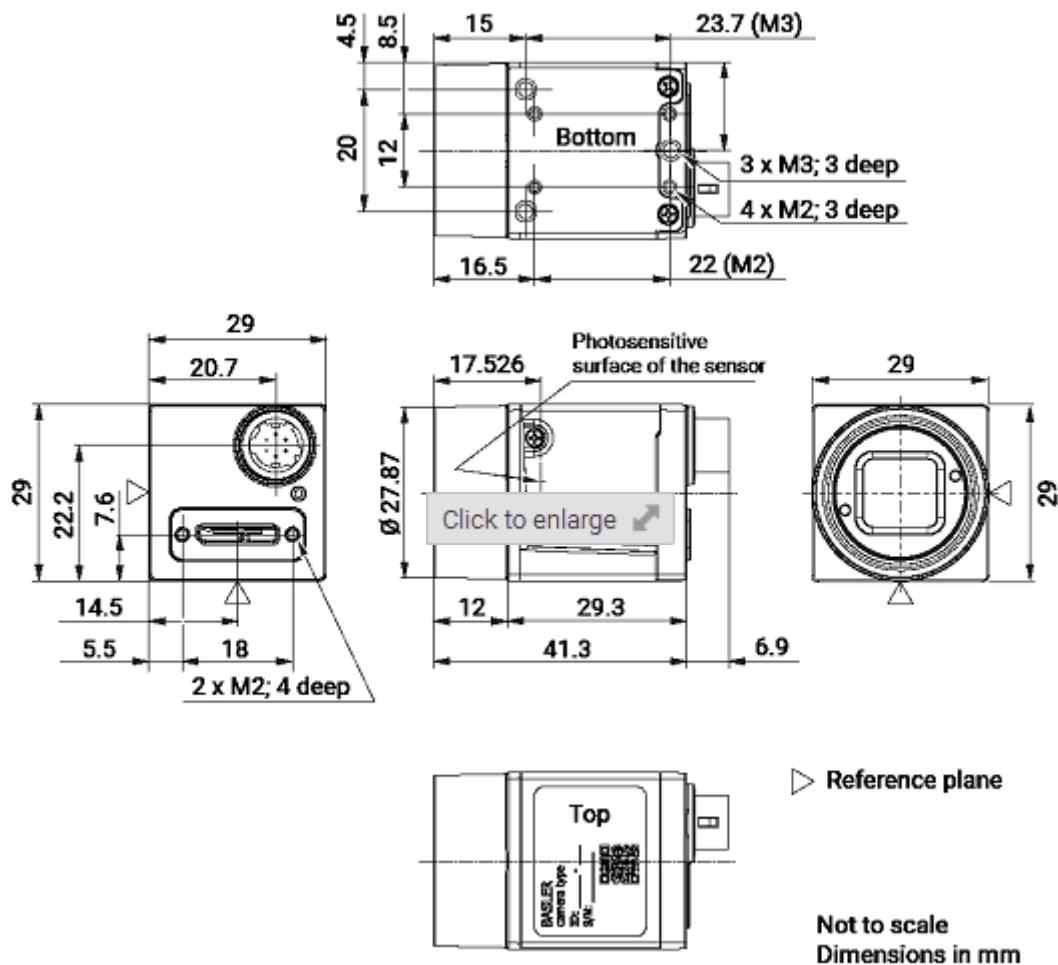

Maximum Allowed Lens Intrusion

→ See [Maximum Allowed Lens Intrusion](#).

Mounting Instructions

→ See [Mounting Instructions](#).

Stress Test Results

→ See [Stress Test Results](#).

Requirements

Environmental Requirements

Temperature and Humidity

Housing temperature during operation	0–50 °C (32–122 °F)
Humidity during operation	20–80 %, relative, non-condensing
Storage temperature	-20–80 °C (-4–176 °F)
Storage humidity	20–80 %, relative, non-condensing
Housing temperature according to UL 60950-1	max. 70 °C (158 °F)
Ambient temperature according to UL 60950-1	max. 30 °C (86 °F)
UL 60950-1 test conditions: no lens attached to camera; no heat dissipation measures; ambient temperature kept at 30 °C (86 °F).	

Heat Dissipation

→ See [Providing Heat Dissipation](#).

Electrical Requirements

⚠ DANGER	
Electric Shock Hazard	▼
⚠ WARNING	
Fire Hazard	▼
NOTICE	
Incorrect voltage can damage the camera.	▼

Camera Power

You must supply camera power that complies with the Universal Serial Bus 3.0 specification.

The camera's nominal operating voltage is 5 VDC, effective on the camera's connector.

Opto-Coupled I/O Input Line

Voltage	Description
30 VDC	Absolute maximum. This voltage must never be exceeded. Doing so may damage the camera and voids the warranty.
0–24 VDC	Safe operating range.
0–1.4 VDC	Indicates a logical 0 (with inverter disabled).
>1.4–2.2 VDC	Region where the logic level transition occurs; the logical status is not defined in this region.
>2.2 VDC	Indicates a logical 1 (with inverter disabled).
<ul style="list-style-type: none">• Minimum current: 5 mA• Current draw: 5–15 mA	

Opto-Coupled I/O Output Line

Voltage	Description
30 VDC	Absolute maximum. This voltage must never be exceeded. Doing so may damage the camera and voids the warranty.
3.3–24 VDC	Safe operating range.
<3.3 VDC	Unreliable I/O output.
<ul style="list-style-type: none">• Leakage current: <60 μA. Actual leakage depends on operating temperature and production spread of electronic components.• Maximum load current: 50 mA• Minimum load current: Not specified. Consider the following:<ul style="list-style-type: none">• Leakage current will have a stronger effect when load currents are low.• Propagation delay of the output increases as load currents decrease.• Higher-impedance circuits tend to be more susceptible to EMI.• Higher currents cause higher voltage drops in long cables.	

General Purpose I/O Lines

Applying incorrect electrical signals to the camera's GPIO line can severely damage the camera.



Operation as Input

Voltage	Description
30 VDC	Absolute maximum. This voltage must never be exceeded. Doing so may damage the camera and voids the warranty.
0–5 VDC	Safe operating range. The minimum external pull-up voltage is 3.3 VDC.
0–0.8 VDC	Indicates a logical 0 (with inverter disabled).
>0.8–2.0 VDC	Region where the logic level transition occurs; the logical status is not defined in this region.
>2.0 VDC	Indicates a logical 1 (with inverter disabled).
<ul style="list-style-type: none">• Current draw (high-level): <100 μA• Sink current: Your application must be able to accept 2 mA sink current from the GPIO input line without exceeding 0.8 VDC.	

Operation as Output

Voltage	Description
30 VDC	Absolute maximum. This voltage must never be exceeded. Doing so may damage the camera and voids the warranty.
3.3–24 VDC	Safe operating range.
<3.3 VDC	Unreliable GPIO output.
<ul style="list-style-type: none">• Internal pull-up resistor: \approx2 kΩ, with open collector. Many applications will have to provide an additional pull-up resistor.• Residual voltage ("on" state): \approx0.4 V at 50 mA and 25 $^{\circ}$C (77 $^{\circ}$F) housing temperature. Actual residual voltage depends on operating temperature, load current, and production spread of electronic components.• Leakage current: <60 μA. Actual leakage depends on operating temperature and production spread of electronic components.• Maximum load current: 50 mA• Minimum load current: Not specified. However, consider the following:<ul style="list-style-type: none">• Leakage current will have a stronger effect when load currents are low.• Propagation delay of the output increases as load currents decrease.• Higher-impedance circuits tend to be more susceptible to EMI.	

- Higher currents cause higher voltage drops in long cables.

Circuit Diagrams

→ See [Circuit Diagrams for Basler ace Cameras](#).

Cable Requirements

USB 3.0 Cable

- Use a high-quality USB 3.0 cable with a Micro-B plug.
- To **avoid EMI**, cables must be shielded, as specified in the USB 3.0 standard.
- Basler recommends using USB 3.0 cables from the [Basler Vision Components](#) range.

For more information about recommended USB 3.0 cables, see the [Recommended Accessories for Basler USB 3.0 Cameras](#) document.

I/O Cable

- The I/O cable must be shielded.
- The I/O cable must have a cross-section at least 0.14 mm² (close to AWG26).
- Use twisted pair wire cables.
- Maximum recommended cable length: 10 m
- Camera-side connector: Hirose micro plug (part number HR10A-7P-6S) or equivalent
- Close proximity to strong magnetic fields should be avoided.
- Basler recommends using I/O cables from the [Basler Vision Components](#) range:
 - [GPIO cable, 10 m](#) (yellow cable): For use with the [GPIO lines](#) of your camera. To avoid interferences due to crosstalk, the opto-coupled I/O lines are not connected.
 - [Opto-I/O cable, 10 m](#) (blue cable): For use with the [opto-coupled I/O lines](#) of your camera. To avoid interferences due to crosstalk, the GPIO lines are not connected.
 - [Opto-GPIO Y-cable, 2 x 10 m](#) (yellow-blue cable): Allows you to use the [GPIO lines](#) and the [opto-coupled I/O lines](#) simultaneously without interferences due to crosstalk. There are two separate wires to split both I/O types.

Physical Interface

Camera Connectors and Status LED

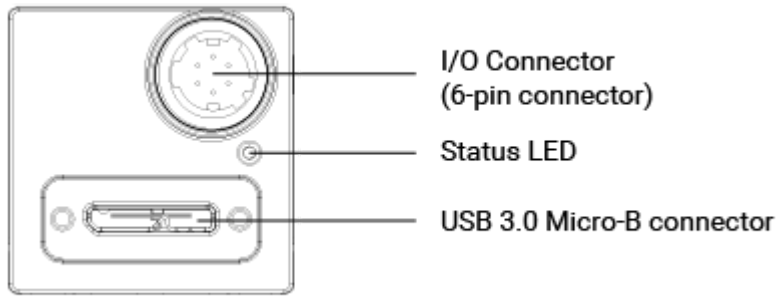

6-pin connector	Hirose micro receptacle (part number HR10A-7R-6PB) Recommended mating connector: Hirose micro plug (part number HR10A-7P-6S)
USB 3.0 Micro-B connector	Standard USB 3.0 Micro-B connector with screw lock Recommended mating connector: Standard connector with screws
Status LED	Indicates camera operation (LED lit = camera operating).

Connector Pin Numbering and Assignments

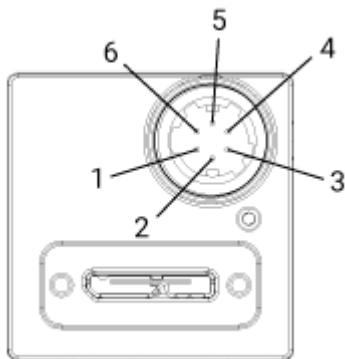

Pin	Line	Function
1	Line 3	General purpose I/O (GPIO) line
2	Line 1	Opto-coupled I/O input line
3	Line 4	General purpose I/O (GPIO) line
4	Line 2	Opto-coupled I/O output line
5	-	Ground for opto-coupled I/O lines
6	-	Ground for General Purpose I/O (GPIO) lines

Precautions

→ See [Safety Instructions for Basler ace Cameras](#).

Installation

→ See [Camera Installation](#).

Features

→ See the [camera features section](#).

Suggestions for improving the documentation? Send us your [feedback on this topic](#).

For technical questions, please contact your [local distributor](#) or use the [support form](#) on the Basler website.