



See the possibilities

User's Manual

LT-400CL

*3CMOS High Speed Color
Line Scan Camera*

Document Version: Ver.1.3
LT-400CL_Ver.1.3_Nov2011

Notice

The material contained in this manual consists of information that is proprietary to JAI Ltd., Japan and may only be used by the purchasers of the product. JAI Ltd., Japan makes no warranty for the use of its product and assumes no responsibility for any errors which may appear or for damages resulting from the use of the information contained herein. JAI Ltd., Japan reserves the right to make changes without notice.

Company and product names mentioned in this manual are trademarks or registered trademarks of their respective owners.

Warranty

For information about the warranty, please contact your factory representative.

Certifications

CE compliance

As defined by the Directive 2004/108/EC of the European Parliament and of the Council, EMC (Electromagnetic compatibility), JAI Ltd., Japan declares that LT-400CL complies with the following provisions applying to its standards.

CISPR Pub.22 (Emission)

CISPR Pub.24 (Immunity)

IEC61000-4-2 Conforming Level 4 (Electrostatic discharge immunity test)

FCC

This equipment has been tested and found to comply with the limits for a Class B digital device, pursuant to Part 15 of the FCC Rules. These limits are designed to provide reasonable protection against harmful interference in a residential installation. This equipment generates, uses and can radiate radio frequency energy and, if not installed and used in accordance with the instructions, may cause harmful interference to radio communications. However, there is no guarantee that interference will not occur in a particular installation. If this equipment does cause harmful interference to radio or television reception, which can be determined by turning the equipment off and on, the user is encouraged to try to correct the interference by one or more of the following measures:

- Reorient or relocate the receiving antenna.
- Increase the separation between the equipment and receiver.
- Connect the equipment into an outlet on a circuit different from that to which the receiver is connected.
- Consult the dealer or an experienced radio/TV technician for help.

Warning

Changes or modifications to this unit not expressly approved by the party responsible for FCC compliance could void the user's authority to operate the equipment.

Supplement

The following statement is related to the regulation on “ Measures for the Administration of the control of Pollution by Electronic Information Products “ , known as “ China RoHS “ . The table shows contained Hazardous Substances in this camera.

 mark shows that the environment-friendly use period of contained Hazardous Substances is 15 years.

重要注意事项

有毒，有害物质或元素名称及含量表

根据中华人民共和国信息产业部『电子信息产品污染控制管理办法』，本产品《有毒，有害物质或元素名称及含量表》如下。

| 部件名称 | 有毒有害物质或元素 | | | | | |
|-------|-----------|-----------|-----------|-----------------|---------------|-----------------|
| | 铅 (Pb) | 汞 (Hg) | 镉 (Cd) | 六价铬 (Cr(VI)) | 多溴联苯 (PPB) | 多溴二苯醚 (PBDE) |
| 棱镜 | × | ○ | ○ | ○ | ○ | ○ |
| 光学滤色镜 | × | ○ | × | ○ | ○ | ○ |
| 镜头座 | × | ○ | ○ | ○ | ○ | ○ |
| 连接插头 | × | ○ | ○ | ○ | ○ | ○ |
| 电路板 | × | ○ | ○ | ○ | ○ | ○ |
| | | | | | | |

○：表示该有毒有害物质在该部件所有均质材料中的含量均在SJ/T11363-2006规定的限量要求以下。
 ×：表示该有毒有害物质至少在该部件的某一均质材料中的含量超出SJ/T11363-2006规定的限量要求。
 （企业可在此处、根据实际情况对上表中打“×”的技术原因进行进一步说明。）



环保使用期限

电子信息产品中含有的有毒有害物质或元素在正常使用的条件下不会发生外泄或突变、电子信息产品用户使用该电子信息产品不会对环境造成严重污染或对基人身、财产造成严重损害的期限。

数字「15」为期限15年。

- Contents -

| | | |
|---|--|----|
| 1. | General | 5 |
| 2. | Camera nomenclature | 5 |
| 3. | Main features | 5 |
| 4. | Locations and functions..... | 6 |
| 4.1. | Main unit..... | 6 |
| 4.2. | Rear Panel and indicators..... | 7 |
| Note: Factory default settings for both functions are “OFF” . | | 7 |
| 5. | Input and output (connectors, signals and circuits)..... | 8 |
| 5.1. | 12-Pin Connector (Hirose) | 8 |
| 5.2. | Digital Output / Interface Connectors for Camera Link..... | 8 |
| 5.3. | Camera Link output | 9 |
| 5.4. | Input and output circuits..... | 11 |
| 5.4.1 | Trigger input | 11 |
| 5.4.2 | EEN/XEEN output (Exposure Enable) | 11 |
| 6. | Functions and Operation..... | 12 |
| 6.1. | Basic functions..... | 12 |
| 6.2. | Sensor layout and output timing..... | 12 |
| 6.3. | Key functions..... | 13 |
| 6.3.1 | Line rate (Command LR) | 13 |
| 6.3.2 | Electronic shutter (Exposure) (Command PER, PEG, PEB)..... | 13 |
| 6.3.3 | EEN (Exposure Enable) function | 14 |
| 6.3.4 | White balance | 14 |
| 6.3.5 | Gain control..... | 15 |
| 6.3.6 | Setup level | 16 |
| 6.3.7 | Knee correction | 17 |
| 6.3.8 | PRNU (Pixel Response Non-Uniformity) correction..... | 17 |
| 6.3.9 | DSNU (Dark Signal Non-Uniformity) correction | 18 |
| 6.3.10 | Shading correction | 19 |
| 6.3.11 | Binning..... | 20 |
| 6.3.12 | Sub-sampling..... | 20 |
| 6.3.13 | Windowing..... | 20 |
| 6.3.14 | Test pattern generator..... | 20 |
| 6.4. | Operation modes | 22 |
| 6.4.1 | No-shutter mode with internal trigger..... | 22 |
| 6.4.2 | No-shutter mode with external trigger | 24 |
| 6.4.3 | Shutter-select mode with internal trigger | 26 |
| 6.4.4 | Shutter-select mode with external trigger..... | 28 |
| 6.4.5 | Pulse Width Control (PWC) mode..... | 31 |
| 6.4.6 | Compatibility of trigger modes and functions..... | 33 |
| 7. | Configuring the camera | 34 |
| 7.1. | RS-232C control..... | 34 |
| 7.2. | LT-400CL Command list | 35 |
| 8. | Functions listed alphabetically by command acronyms | 40 |
| 8.1. | Command AH - One-push AWB shutter..... | 40 |
| 8.2. | Command AHRS - Request status after One-Push AWB..... | 40 |
| 8.3. | Command AL - Automatic Line Rate Reference Level | 40 |
| 8.4. | Command AR - Automatic Line Rate setting | 40 |
| 8.5 | Command ARST - Auto reset mode..... | 41 |
| 8.6 | Command AW - Activate One-push Auto White Balance (AWB) - Gain | 41 |
| 8.7 | Command AWRS - Inquire the status after one-push AWB..... | 41 |
| 8.8 | Command BA - Bit Allocation..... | 41 |
| 8.9 | Command BI - Binning (Horizontal only)..... | 42 |
| 8.10 | Command BL - Master Black Level | 42 |

| | | |
|----------------|---|----|
| 8.11 | Commands BLR and BLB - Black level red and black level blue | 42 |
| 8.12 | Command BLM - Black level mode | 42 |
| 8.13 | Command EI - Interlocked R and B exposure with G | 42 |
| 8.14 | Command GA - Gain level master / G channel..... | 43 |
| 8.15 | Commands GAR and GAB - Red and blue gain levels..... | 43 |
| 8.16 | Command GM - Gain mode | 43 |
| 8.17 | Command KN - Knee ON/Off | 43 |
| 8.18 | Commands KSR, KSG and KSB - Knee slope for R, G and B..... | 43 |
| 8.19 | Commands KPR, KPG and KPB - Knee point for R, G and B..... | 43 |
| 8.20 | Command LR - Line Rate (Scan Rate) | 44 |
| 8.21 | Command NR - Noise reduction | 44 |
| 8.22 | Command PBC - Select pixel black correction mode..... | 44 |
| 8.23 | Command PBR - Run pixel black correction and store to user area | 44 |
| 8.24 | Command PBS - Inquire the status of after pixel black correction | 45 |
| 8.25 | Command PER - Programmable exposure - Red..... | 45 |
| 8.26 | Command PEG - Programmable exposure - Green | 45 |
| 8.27 | Command PEB - Programmable exposure - Blue | 45 |
| 8.28 | Command PGC - Pixel gain correction mode | 45 |
| 8.29 | Command PGR - Run pixel gain correction and store in user area..... | 46 |
| 8.30 | Command PGS - Inquire the status after pixel gain correction..... | 46 |
| 8.31 | Command SDC - Select shading correction mode..... | 46 |
| 8.32 | Command SDR - Run shading correction | 46 |
| 8.33 | Command SDS - Request status after executing shading correction command | 48 |
| 8.34 | Commands SGR,SGG,SGB - Gain Low, High..... | 48 |
| 8.35 | Command SRO - Sensor read out | 48 |
| 8.36 | Command TG - Trigger Origin..... | 48 |
| 8.37 | Command TI - Trigger input..... | 48 |
| 8.38 | Command TP - Trigger polarity..... | 49 |
| 8.39 | Command TR - Trigger Mode..... | 49 |
| 8.40 | Command TS - Test pattern..... | 49 |
| 8.41 | Command WB - White Balance | 49 |
| 9. | Camera Control Tool for LT-400CL | 50 |
| 10. | External appearance and Dimensions | 53 |
| 11 | . Specifications..... | 55 |
| 11.1 | Typical data..... | 55 |
| 11.2 | Spectral sensitivity..... | 58 |
| Appendix | | 59 |
| 1. | Precautions | 59 |
| 2. | Typical Sensor Characteristics..... | 59 |
| 3. | Caution when mounting a lens on the camera..... | 59 |
| 4. | Caution when mounting the camera..... | 59 |
| 5. | Exportation | 60 |
| 6. | References..... | 60 |
| Change History | | 61 |
| User's Record | | 62 |

1. General

LT-400CL is a 3CMOS line scan camera using three 4096 pixel line sensors mounted on a prism, for the R, G and B channels. It operates with an 80 MHz pixel clock, resulting in a maximum line rate of 16,180 lines per second.

The camera outputs digital data in 3 x 8 bits or 3 x 10 bits format via Camera Link. The camera is configured by software through the serial communication port of the Camera Link interface, or via RS-232C through a 12-pin Hirose connector.

The camera accepts M52 or F-mount lens.

The latest version of this operation manual can be downloaded from www.jai.com.

The latest camera control tool for the LT-400CL can be downloaded from www.jai.com.

For camera revision history, please contact your local JAI distributor

2. Camera nomenclature

The standard camera composition consists of:

| | |
|-----------------------------------|-----|
| LT-400CL camera body with F mount | x 1 |
| Lens mount/sensor protection cap | x 1 |

The camera is available in the following versions:

LT-400CL-M52/-F

Where L stands for “Linear sensor” family, T stands for “Tri sensor”, 400 represents the resolution “4000 pixels”, 400 represents variation with the same resolution and CL stands for “CameraLink®” interface. M52 stands for M52 lens mount version and F stands for the Nikon F mount version

3. Main features

- 3CMOS line scan camera with 4096 pixel resolution
- Dichroic RGB beam splitter prism
- 16,180 lines per second scan rate
- 80 MHz pixel clock
- 3 x 8 bits or 3 x 10 bits output through Camera Link interface
- Flat-field correction. Pixel-by-pixel compensation on each RGB channel
- Flat shading compensation
- Color shading compensation
- One-push white balance
- Knee correction
- Noise reduction circuit ON/OFF
- Pixel binning
- Sub-sampling readout
- Windowing readout
- Test pattern generator(color bar, gray, white) for set-up and troubleshooting
- Electronic shutter (for shutter selected modes)
- Lens mount is M52 as a standard and F mount as a factory option
- DC input range from +12 V to +24V
- Short ASCII commands for set-up via RS 232C or Camera Link
- Setup by Windows XP software

4. Locations and functions

4.1. Main unit

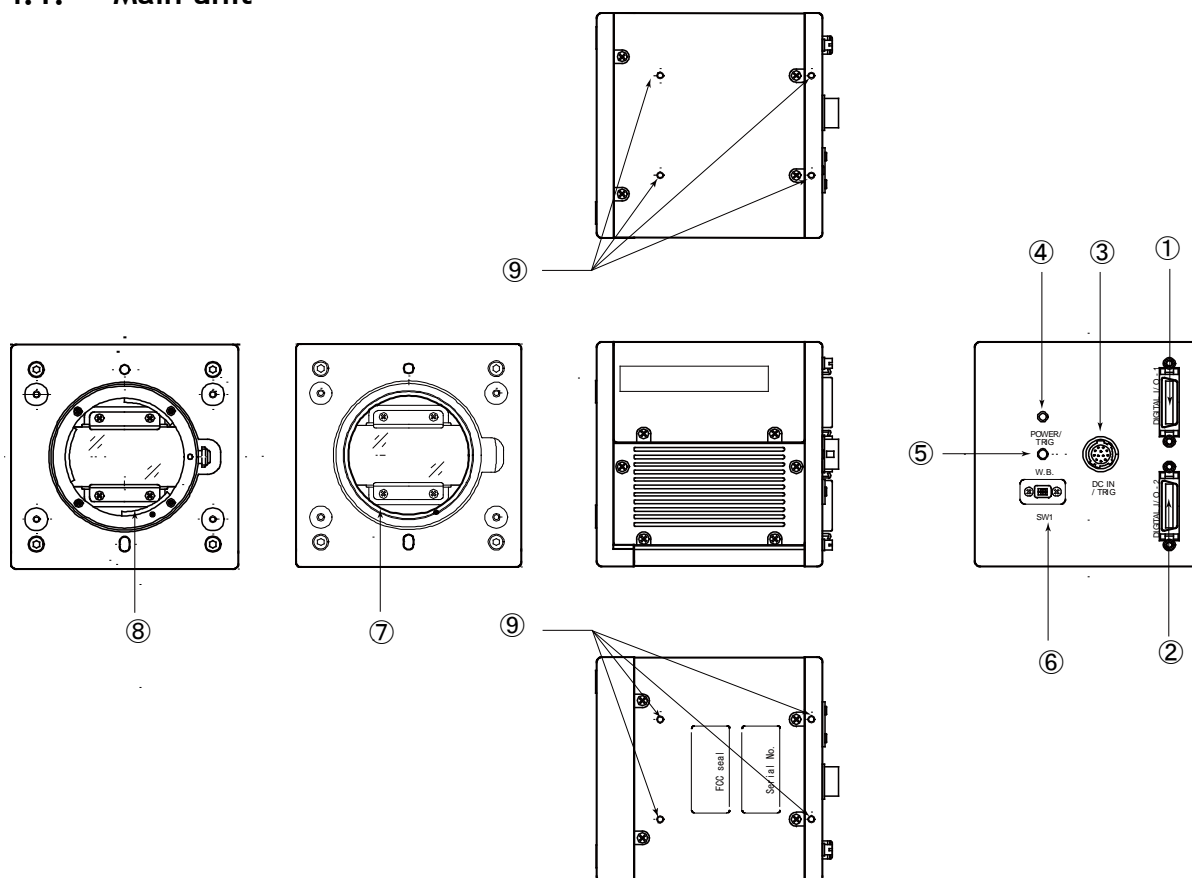

Fig. 1 Location of external features

- 1 Camera Link base connector (1) (*Note1)
- 2 Camera Link medium connector (2) (*Note1)
- 3 12-pin Hirose connector for DC +12, External trigger and RS-232C
- 4 LED indicator Orange, steady: Initializing or one-push operation
 Green, steady: Operating, but not receiving external trigger
 Green, flashing: Operating and receiving external trigger
- 5 One-push auto white balance button
- 6 SW-1 (refer to chapter 4.2)
- 7 M52 lens mount (Note 2)
- 8 Nikon F-Mount lens mount(Note2)
- 9 Mounting holes 8 x M3, depth 5mm (*Note3)

***Note1:** When a Camera Link cable is connected to the camera, please do not excessively tighten screws by using driver. The Camera Link receptacle on the camera might be damaged. For security, the strength to tighten screws is less than 0.291 Newton Meter (Nm). Tightening by hand is sufficient in order to achieve this.

***Note2:** The rear protrusion of lens should be within 13mm for both M52 mount lens and Nikon-F mount lens.

***Note3:** The depth of mounting hole is 5mm ± 0.2mm. If the longer screws than 5.2mm are used, they may damage the circuit board inside.

4.2. Rear Panel and indicators

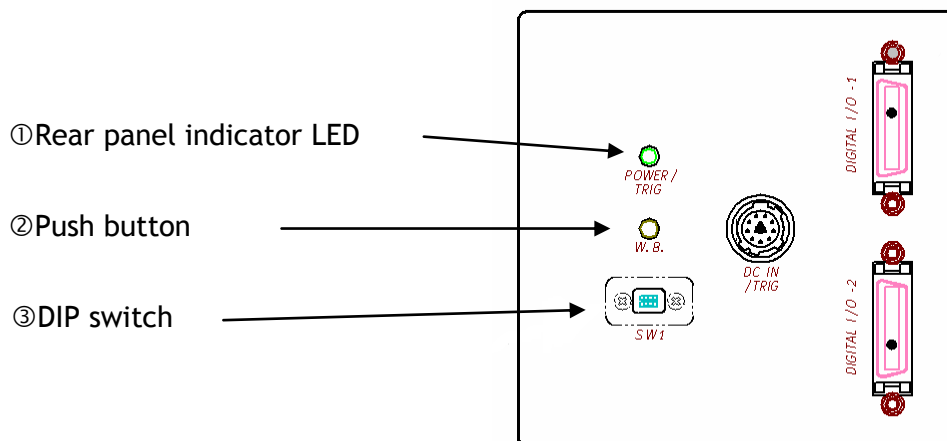

Fig.2 Rear panel

① LED

There is a multi-color LED on the rear panel of the camera. It has the following functions:

- **Green (Steady)**
Operating, but not receiving external trigger input
- * **Green (Flashing)**
Operating and receiving external trigger input.
Note that the flashing frequency does not correspond to the frequency of the trigger signal.
Note: In no-shutter/internal and shutter select/internal modes, this LED does not flash.
- **Orange**
Initializing or executing one-push white balance

② Push button

This push button is used for gain white balance.

③ DIP switch

SW-1 function

| No | Function | Settings | |
|----|---------------------------------|--------------|-------------------|
| | | ON | OFF |
| 1 | Serial communication | Hirose 12Pin | Camera link (CC1) |
| 2 | Termination of External trigger | 75 Ω | TTL |

Note: Factory default settings for both functions are “OFF”.

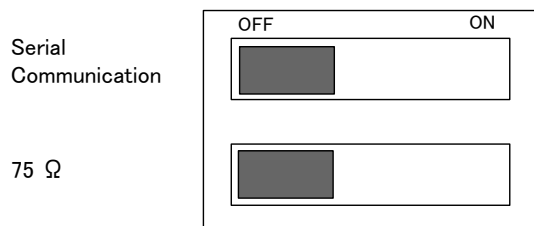

Fig.3 DIP switch

5. Input and output (connectors, signals and circuits)

5.1. 12-Pin Connector (Hirose)

Type: HR10A-10R-12PB(71) Hirose (Male)

Use the part number HR10A-10P-12S for the cable side

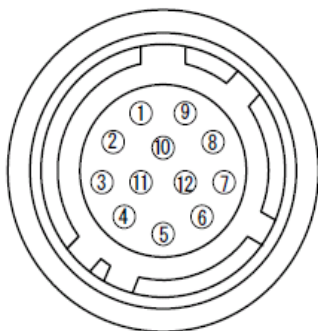

| Pin No. | Signal | Remarks |
|---------|------------|------------------------------------|
| 1 | GND | |
| 2 | DC in | +12V to +24V |
| 3 | GND | |
| 4 | Reserved | Do not connect |
| 5 | GND | |
| 6 | RxD in | RS-232C |
| 7 | TxD out | RS-232C |
| 8 | GND | |
| 9 | XEEN out | |
| 10 | Trigger in | TI=1, or set TI=0 for input via CL |
| 11 | NC | |
| 12 | GND | |

Fig.4 12-pin Hirose connector

5.2. Digital Output / Interface Connectors for Camera Link

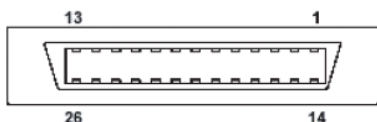

Type: 26P MRD Connector 3M 110226-1A10PL

Fig. 5 Camera Link connector

This camera can be used with all Camera Link products that comply with the AIA Camera Link standard. Cables, transmission systems and frame grabbers/acquisition boards that do not comply with the Camera Link standard may work with this camera, but JAI Camera Solutions cannot be held responsible for loss in performance or damage of equipment, including the camera.

Recommended cable assembly

3M 14B26-SZLB-XXX-OLC (where XXX is the length of cable)

The applicable cable length is 0.5m to 10m.

14B26-SZ3B-XXX-03V(small diameter type) and 14B26-SZ3B-XXX-04C(high flexion type) can be used but the length will be limited.

Connector 1 (24Bit, 30 Bit)

| Pin No | In/Out | Name | Note |
|-------------|--------|---------------|---------------------|
| 1,14 | | Shield | GND |
| 2(-),15(+) | O | TxOUT0 | Data out |
| 3(-),16(+) | O | TxOUT1 | |
| 4(-),17(+) | O | TxOUT2 | |
| 5(-),18(+) | O | TxCclk | Clock for CL |
| 6(-),19(+) | O | TxOUT3 | Data out |
| 7(+),20(-) | I | SerTC (RxD) | LVDS Serial Control |
| 8(-),21(+) | O | SerTFG (TxD) | |
| 9(-),22(+) | I | CC1 (Trigger) | Trigger |
| 10(+),23(-) | I | CC2(Reserved) | |
| 11,24 | | N.C | |
| 12,25 | | N.C | |
| 13,26 | | Shield | GND |

LT-400CL

Connector 2 (Used only for 3 x 10 Bit output)

| Pin No | In/Out | Name | Note |
|-------------|--------|--------|--------------|
| 1,14 | | Shield | GND |
| 2(-),15(+) | 0 | TxOUT0 | Data out |
| 3(-),16(+) | 0 | TxOUT1 | |
| 4(-),17(+) | 0 | TxOUT2 | |
| 5(-),18(+) | 0 | TxCk | Clock for CL |
| 6(-),19(+) | 0 | TxOUT3 | Data out |
| 7(+),20(-) | | N.C | |
| 8(-),21(+) | | N.C | |
| 9(-),22(+) | | N.C | |
| 10(+),23(-) | | N.C | |
| 11,24 | | N.C | |
| 12,25 | | N.C | |
| 13,26 | | Shield | GND |

The LT-400CL follows the Camera Link standard in all respects.

Please refer to the Camera Link version 1.1 specifications for detailed information on bit assignments of 24-bit RGB and 30-bit bit output.

5.3. Camera Link output

RD9~RD0 : R Channel Camera Data(RD9=MSB, RD0=LSB)

GD9~GD0 : G Channel Camera Data(GD9=MSB, GD0=LSB)

BD9~BD0 : B Channel Camera Data(BD9=MSB, BD0=LSB)

× : Not in use

| Port/Signal | 24bit Output | 30bit Output | Connector | Pin Name |
|-------------|--------------|--------------|-----------|----------|
| Port A0 | RD0 | RD0 | 1 | Tx0 |
| Port A1 | RD1 | RD1 | 1 | Tx1 |
| Port A2 | RD2 | RD2 | 1 | Tx2 |
| Port A3 | RD3 | RD3 | 1 | Tx3 |
| Port A4 | RD4 | RD4 | 1 | Tx4 |
| Port A5 | RD5 | RD5 | 1 | Tx6 |
| Port A6 | RD6 | RD6 | 1 | Tx27 |
| Port A7 | RD7 | RD7 | 1 | Tx5 |
| Port B0 | GD0 | RD8 | 1 | Tx7 |
| Port B1 | GD1 | RD9 | 1 | Tx8 |
| Port B2 | GD2 | × | 1 | Tx9 |
| Port B3 | GD3 | × | 1 | Tx12 |
| Port B4 | GD4 | BD8 | 1 | Tx13 |
| Port B5 | GD5 | BD9 | 1 | Tx14 |
| Port B6 | GD6 | × | 1 | Tx10 |
| Port B7 | GD7 | × | 1 | Tx11 |
| Port C0 | BD0 | BD0 | 1 | Tx15 |
| Port C1 | BD1 | BD1 | 1 | Tx18 |
| Port C2 | BD2 | BD2 | 1 | Tx19 |
| Port C3 | BD3 | BD3 | 1 | Tx20 |
| Port C4 | BD4 | BD4 | 1 | Tx21 |
| Port C5 | BD5 | BD5 | 1 | Tx22 |
| Port C6 | BD6 | BD6 | 1 | Tx16 |
| Port C7 | BD7 | BD7 | 1 | Tx17 |
| Port D0 | × | × | 2 | Tx0 |
| Port D1 | × | × | 2 | Tx1 |
| Port D2 | × | × | 2 | Tx2 |
| Port D3 | × | × | 2 | Tx3 |
| Port D4 | × | × | 2 | Tx4 |
| Port D5 | × | × | 2 | Tx6 |
| Port D6 | × | × | 2 | Tx27 |
| Port D7 | × | × | 2 | Tx5 |
| Port E0 | × | GD0 | 2 | Tx7 |
| Port E1 | × | GD1 | 2 | Tx8 |
| Port E2 | × | GD2 | 2 | Tx9 |
| Port E3 | × | GD3 | 2 | Tx12 |
| Port E4 | × | GD4 | 2 | Tx13 |
| Port E5 | × | GD5 | 2 | Tx14 |
| Port E6 | × | GD6 | 2 | Tx10 |
| Port E7 | × | GD7 | 2 | Tx11 |

6. Functions and Operation

6.1. Basic functions

The LT-400CL is built around three high-performance CMOS line scan image sensors mounted on a prism block, as illustrated in Figure 7.

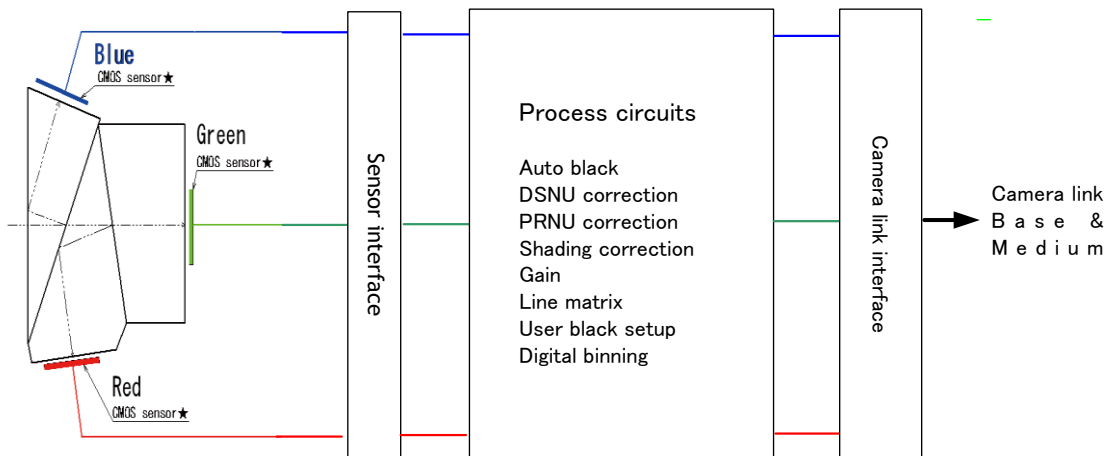
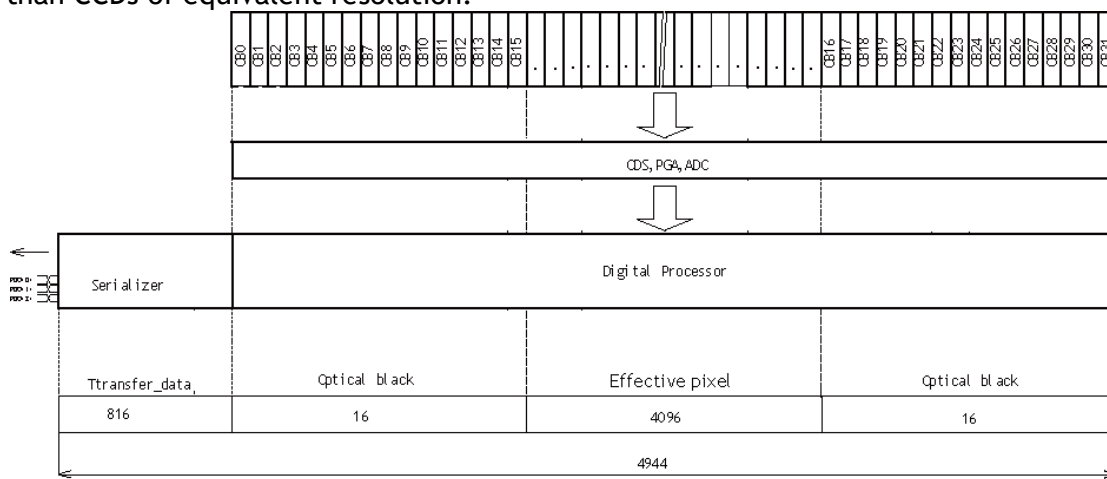

Fig.8 Sensor block diagram

The incoming light is divided into three primary colors, Red, Blue and Green and transmitted to each sensor. The output from each sensor is LVDS and it is converted to parallel digital signals in the sensor interface. Each signal then is transmitted to processing circuits which manipulate in the necessary characteristics and output via the Camera Link interface. The functions in the processing circuits are described in the following sections.

6.2. Sensor layout and output timing

The LT-400CL uses newly developed COMS sensors which have 4096 effective pixels. Light received on photodiodes is converted to electronic signals and these signals are handled in a correlated double sampling circuit, analog gain circuit and analog digital converter circuit. After that, digital signals are serialized and output. All those circuits are inside the sensor package. CMOS sensors can provide higher rates and lower power consumption than CCDs of equivalent resolution.



Note: Dummy pixels have photo diode.

- CB : Optical Black Pixels
- TP : Transition Pixels
- AP : Active Pixels
- Iso : Isolation Stages

Fig.9 Sensor layout

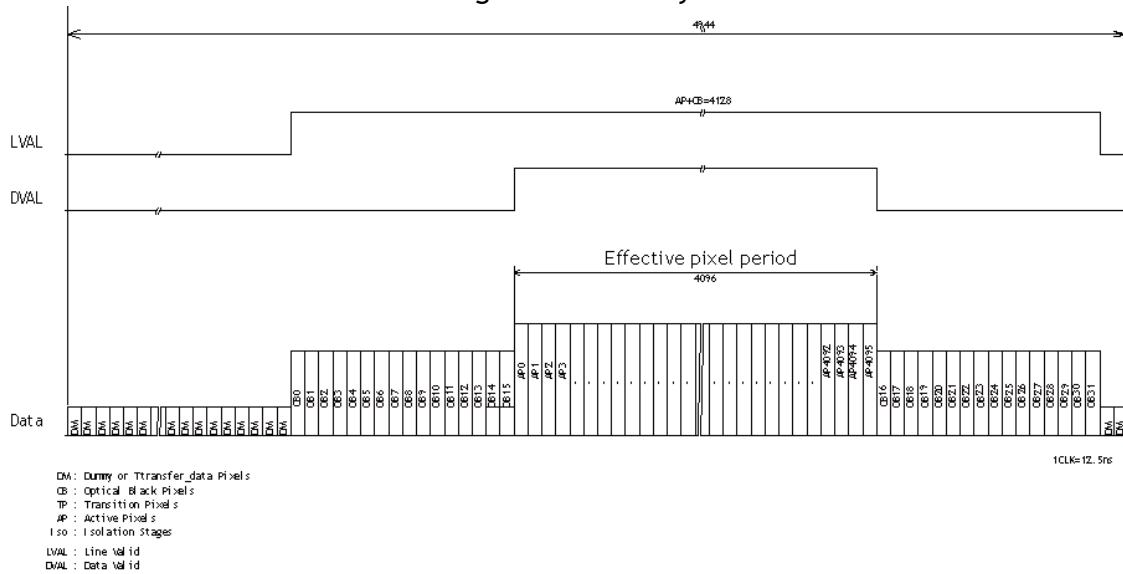

Fig.10 Video output timing

6.3. Key functions

6.3.1 Line rate (Command LR)

This function can set the line rate longer than 1L. Accordingly, it is possible to set the camera scan rate with the object running speed or to boost up the sensitivity by setting longer exposure time.

- ◆ Adjusting range: 61.8μs(1L) to 15.02ms
- ◆ Adjusting unit: 12.5ns
- ◆ Operation mode: TG=0 Internal trigger

The line rate can be automatically configured (one-push auto line set) (Command:AR). This function will calculate and set the line rate of the camera based on the Automatic Line Rate Reference Level (Command :AL) and the scene illumination.

6.3.2 Electronic shutter (Exposure) (Command PER, PEG, PEB)

This function sets the exposure time regardless of line rate setting. The exposure time can be set for red, blue, and green, respectively.

Command PER= 4800 to 1194752
 PEG= 4800 to 1194752
 PEB= 4800 to 1194752

- ◆ Adjusting range: 60μs (4800clk) to 14.93ms (1194752clk)
 (RGB individually)
- ◆ Adjusting unit: 12.5 ns (1clock) (RGB individually)
- ◆ Operation mode: Shutter select/internal trigger and shutter select/external trigger

Note:

Exposure time can be set as mentioned before. However, if the line rate is shorter than the exposure time, the accumulation time is determined by the line rate. This should be noted especially in external trigger mode.

Line rate > Exposure time

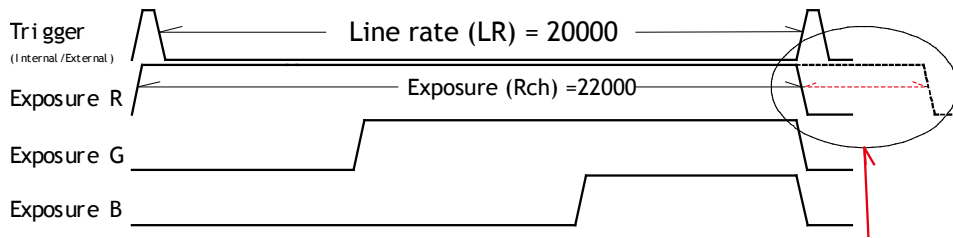

In this case, although the exposure time is set at 22000, but the actual exposure time is limited by the line rate, 20000.

Fig.11 Exposure setting should be less the line rate

6.3.3 EEN (Exposure Enable) function

This function outputs the timing for image accumulation in all operating modes except test pattern output. The output can be through both the Hirose 12-pin and Camera Link connectors. The polarity of this output is negative from the Hirose 12-pin connector and positive from the Camera Link connector. These polarities cannot be changed.

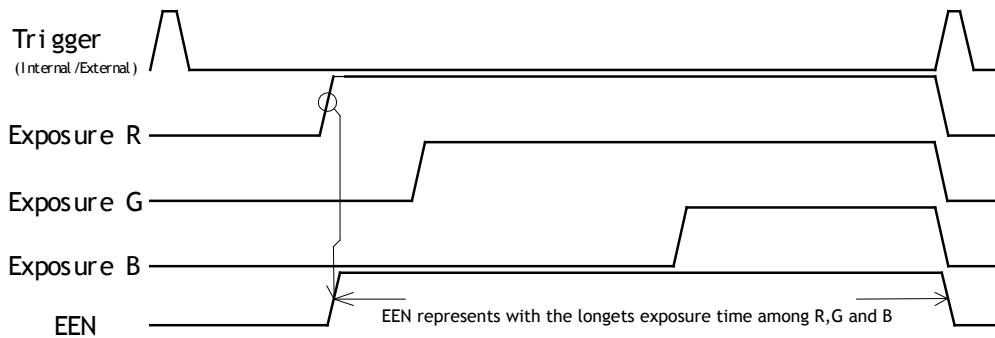

Fig.12 EEN function

6.3.4 White balance

In this function, the green channel video level is used as the reference. Red and blue channel levels are adjusted to match with that of the green channel.

There are two ways to adjust white balance: one is the gain white balance and the other is the shutter white balance.

| White balance | Control tool | Command | | Rear panel switch |
|---------------|--------------|---------|----|-------------------|
| | | WB | AH | |
| Gain | ○ | ○ | × | ○ |
| Shutter | ○ | × | ○ | × |

Gain white balance

Calculates the difference between green and red video levels, and green and blue levels, and adjusts the red and blue channels' video level so that the video level of all three channels becomes equal.

| | | |
|---------|------|---------------------|
| Command | WB=0 | Manual/One push AWB |
| | WB=1 | 4000K |
| | WB=2 | 4600K |
| | WB=3 | 5600K |

Shutter white balance (only for shutter select mode)

Calculates the difference between green and red video levels, and green and blue levels, and adjusts the red and blue channels' shutter speed so that the video level of all three channels becomes equal.

Command AH=0 Activate One push shutter AWB

Note:

If gain and shutter white balance are used in the external trigger mode, external trigger pulses should be continuously provided while white balance adjustment is executing.

6.3.5 Gain control

The LT-400CL has two ways of gain setting - one for the master tracking and the other for individual adjustment. Each setting also has two analog gain modes - one is the GAIN LOW and the other is the GAIN HIGH. When the Gain Low is selected, gain for each channel can be adjusted from -4dB to +14dB as the reference of 0dB which is the default output setting. If the Gain High is selected, the reference level is changed to +6dB and gain for each channel can be adjusted as the reference of +6dB.

The following shows the setting procedures and adjustable range.

1. Master tracking mode

Gain Low mode:

- ◆ Reference value: 0dB
- ◆ Master gain control range : 0dB to 8dB
- ◆ R/B Adjusting range :-4dB to +6dB (at the master gain setting value)

Gain High mode:

- ◆ Reference value: +6dB
- ◆ Master gain control range : 0dB to 8dB
- ◆ R/B Adjusting range :-4dB to +6dB (at the master gain setting value)

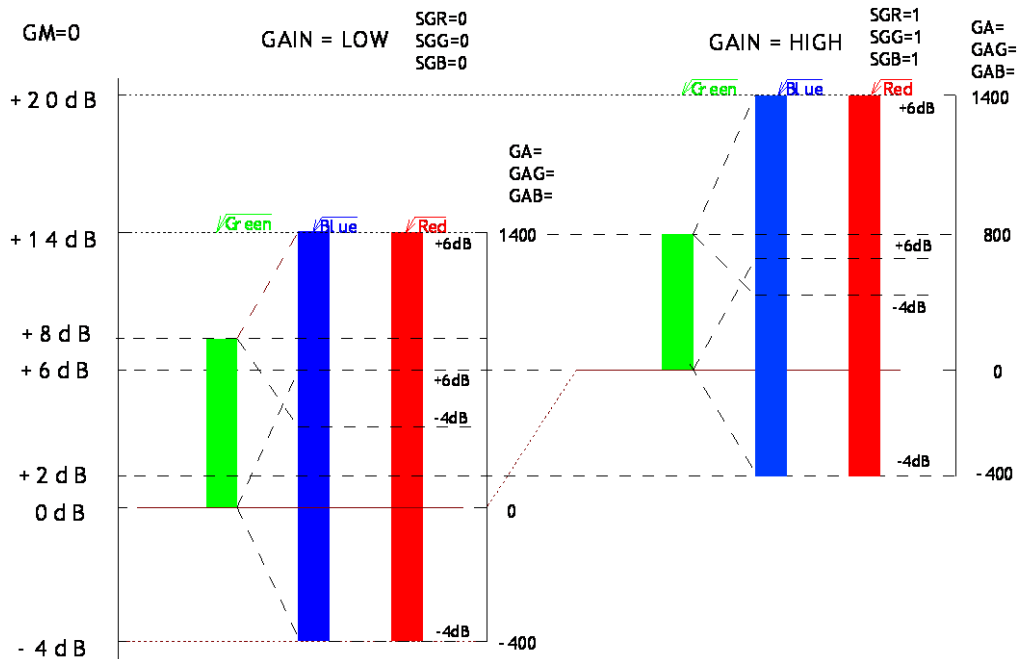

Fig.13 Master gain mode with Gain Low and High

2. Individual gain mode

Gain Low mode:

- ◆ Reference value: 0dB
- ◆ R/G/B Adjusting range : -4dB to +14dB (at the master gain setting value)

Gain High mode:

- ◆ Reference value: +6dB
- ◆ R/G/B Adjusting range : -4dB to +14dB (at the master gain setting value)

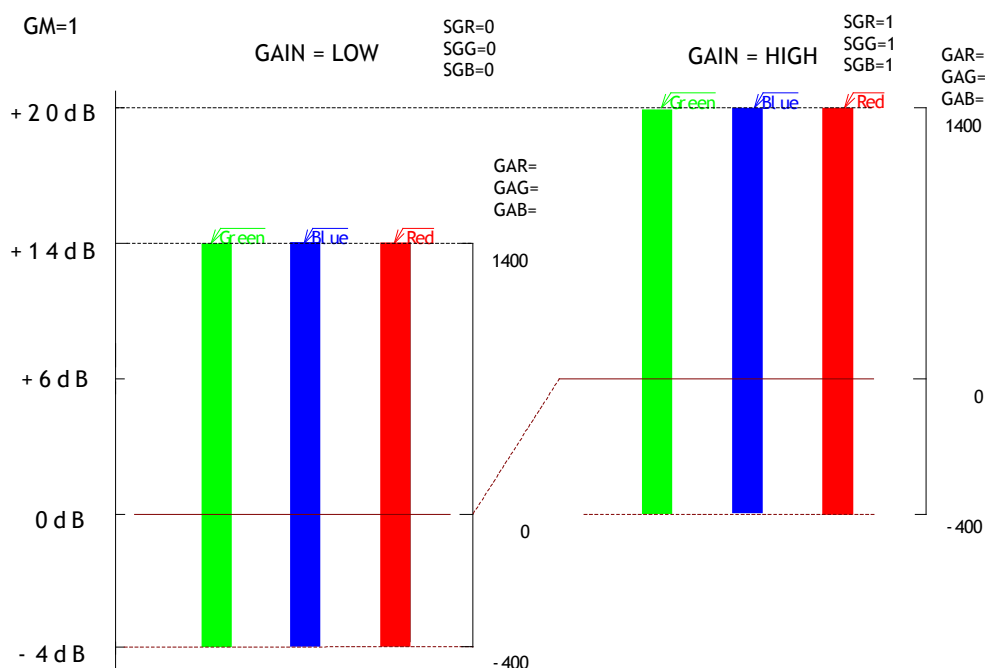

Fig.14 Individual gain mode with gain low and gain high

6.3.6 Setup level

This function adjusts the setup level (black). This depends on the gain mode.

Gain Set at Master tracking mode:

- ◆ Adjusting range Master(green) : 0LSB to 64LSB(16LSB)
 - Red : -64(-16) LSB to +64(16)LSB
 - Blue : -64(-16) LSB to +64(16)LSB
- Figures in () are for 8 bits output

Gain Set at Individual mode:

- ◆ Adjusting range Red : 0LSB to 64(16) LSB
- Green : 0LSB to 64(16) LSB
- Blue : 0LSB to 64(16) LSB

Figures in () are for 8 bits output

Note: Red, green and blue can be adjusted individually

6.3.7 Knee correction

If the relationship of input and output is linear (1:1), the output level will be clipped at a certain input level and cannot reproduce the details in the clipped area. The knee compensation circuit can keep the linear relationship until the knee point, while after the knee point, the output signal is compressed to reproduce the details. This compression area can be set by a knee slope.

The knee point and knee slope can be set individually.

| Function | Length | Variable type | Setting range |
|------------|--------|----------------------|-----------------------------------|
| Knee Point | 10bit | Unsigned integer | 0LSB ~ 1023LSB |
| Knee Slope | 16bit | Unsigned fixed point | 0001h(x0.000015) ~ FFFFh(x1.0000) |

The following drawing shows the characteristics of Knee Point 890LSB and Knee Slope 1000h.

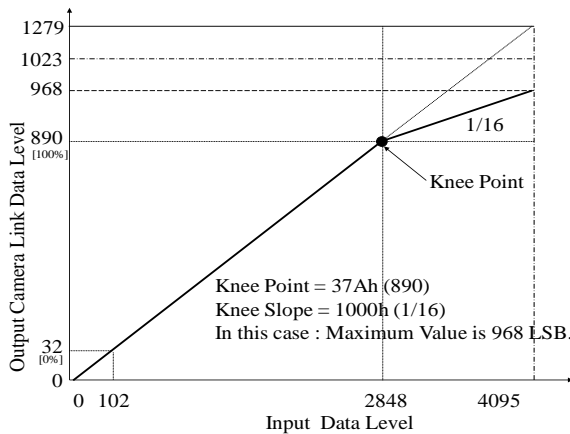

Fig.15 Knee and knee slope characteristics

6.3.8 PRNU (Pixel Response Non-Uniformity) correction

PRNU (Pixel Response Non-Uniformity) is, as the name implies, a non-uniformity of the response of each individual pixel. This means that for a fixed light level each pixel will have a slightly different output level (response).

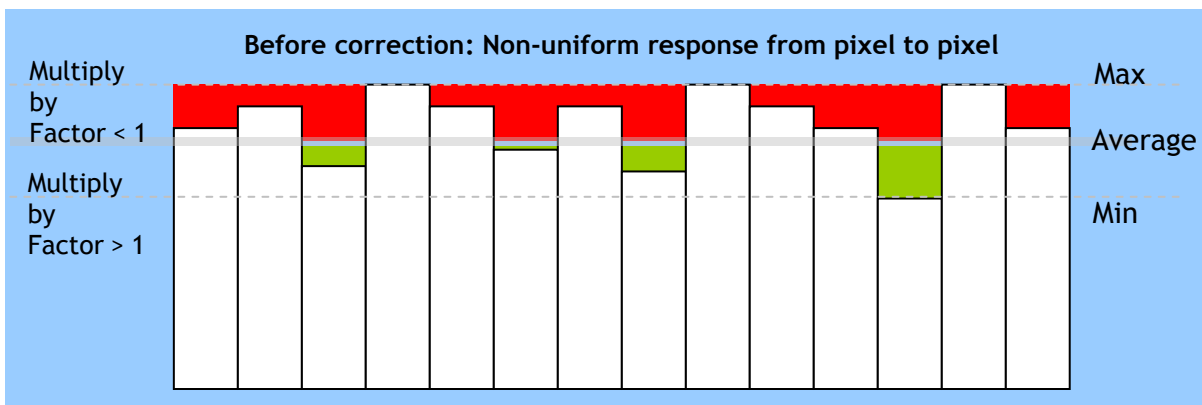

Fig.16 Conceptual drawing for PRNU correction (1)

To correct for PRNU, the camera’s internal correction circuit captures one or several lines of data under non-saturated illuminated conditions which are not more than 80% of maximum (recommend level is half of maximum), and the average across the line is calculated. Based on this average, coefficients are then generated for each individual pixel. The coefficient has the function of multiplying the pixel output with a factor greater or less than 1. These coefficients are stored in a non-volatile memory, and are therefore maintained after power down.

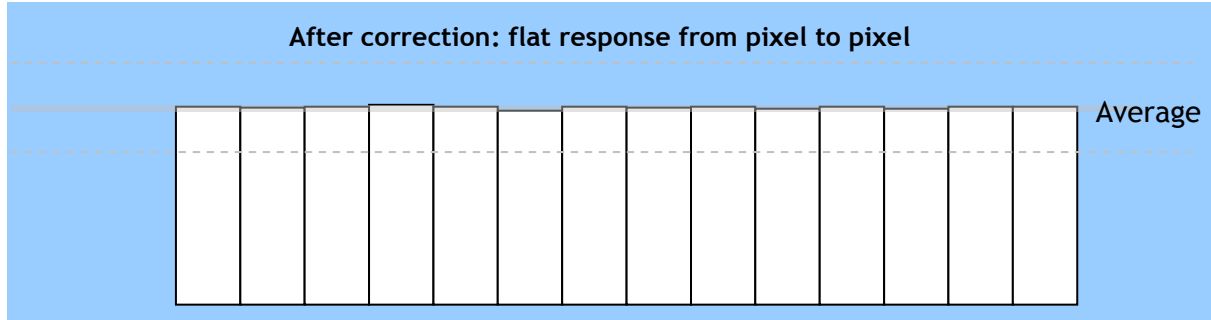

Fig.17 Conceptual drawing for PRNU correction (2)

6.3.9 DSNU (Dark Signal Non-Uniformity) correction

DSNU (Dark Signal Non-Uniformity) is, as the name implies, a non-uniformity of offset level of each pixel, which is *not* dependent on the incoming light.

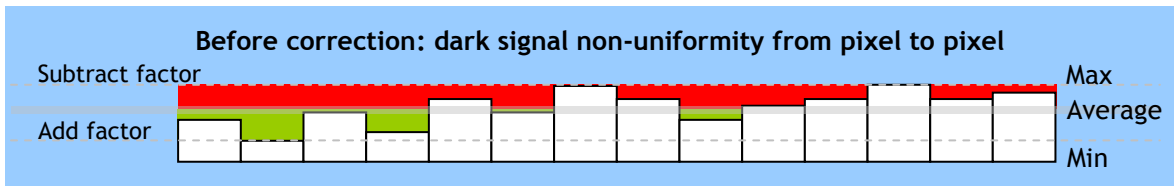

Fig.18 Conceptual drawing of DSNU correction

To correct for DSNU, the camera internal correction circuit captures one or several lines of data under dark conditions (the lens *must* be covered by a lens cap), and the average across the line is calculated. Based on the average, coefficients are then generated for each individual pixel. The coefficient has the function of adding or subtracting a value to the pixel output. These coefficients are stored in a non-volatile memory, and are therefore maintained after power down.

As the dark signal is highly dependent on the exposure time, this correction must be performed under the operating conditions (exposure time and line rate) that will be used by the application.

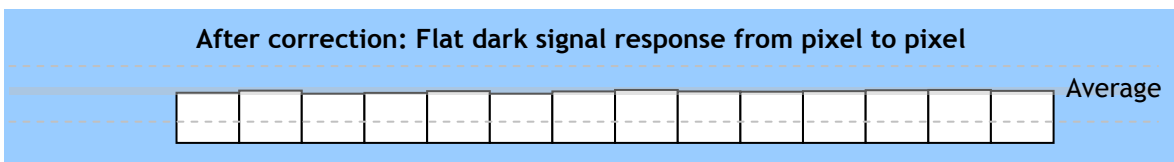

Fig.19 Conceptual drawing of DSNU correction

6.3.10 Shading correction

Shading is caused either by illumination with uneven distribution of light across the surface, or by reductions in the light transmission ratio towards the edges of a lens. The shading correction incorporated in the camera will compensate for this effect by as much as 20% of the brightest signal.

Shading is not compensated for each individual pixel. The signal is averaged across groups of 8 pixels in relation to the whole line. The pixel response non-uniformity will be superimposed on the output also after shading correction has been performed. Therefore, it is recommended to perform PRNU correction before shading correction.

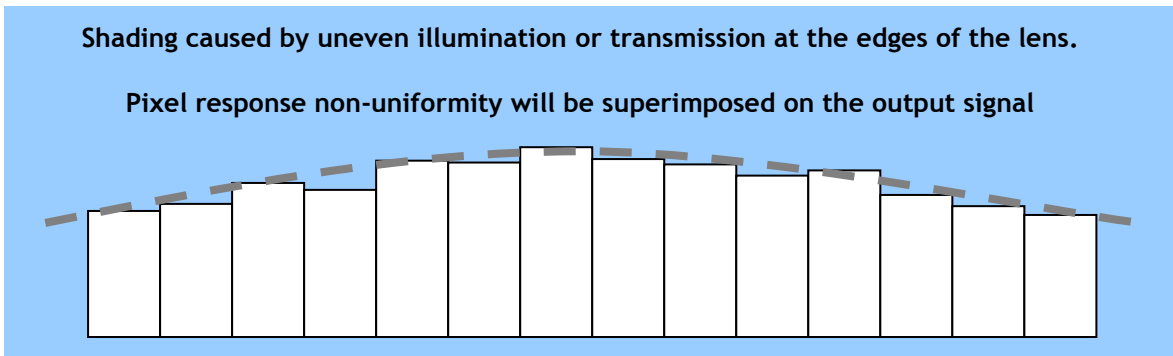

Fig.20 Shading correction

The shading correction has two ways to compensate, flat shading correction and color shading correction.

Flat shading correction compensates red, blue and green signals to be flat output. The range of compensation is within plus-or-minus 20% as compared the brightest signal level. It may not compensate enough according to the lenses and/or lighting in use.

Color shading correction compensates red and blue signals to match with green signal characteristics.

The following drawings show the concepts for flat and color shading corrections.

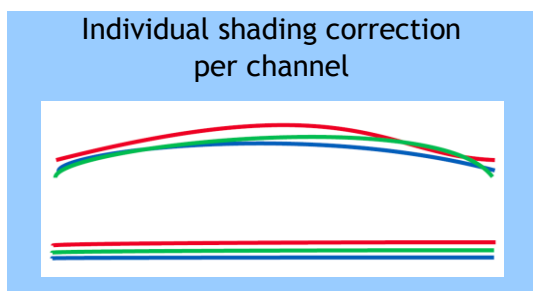

Fig.21 Flat shading correction

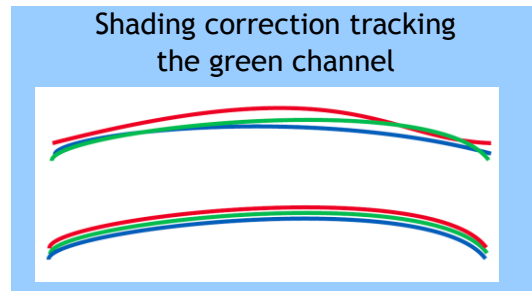

Fig.22 Color shading correction

6.3.11 Binning

In this mode, a camera combines the charge collected in two adjacent pixels. This halves the effective resolution to 2048 pixels, but doubles the sensitivity. The line rate is not affected by binning.

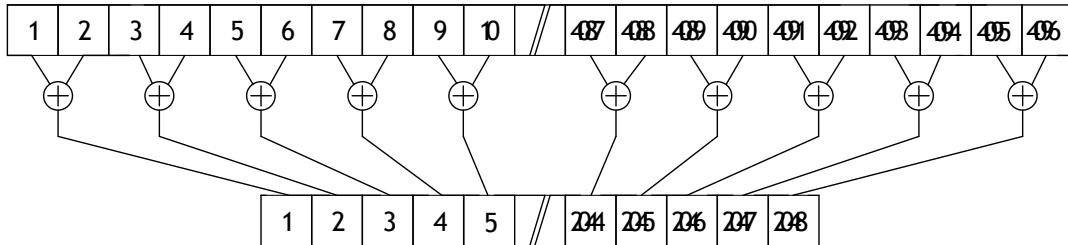

Fig.21 Binning reads out adjacent pixels at the same time

6.3.12 Sub-sampling

In this mode, every two effective pixels are read out. Accordingly, the read out rate is doubled.

The FOV (Field Of View) is not changed versus full scan mode but the resolution becomes half.

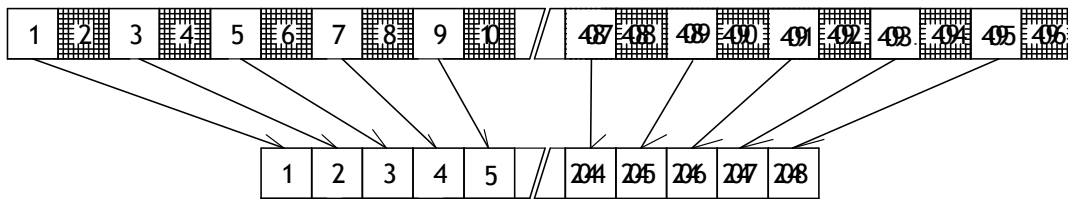

Fig.22 Sub-sampling reads out every two pixels

6.3.13 Windowing

In this mode, only the effective 2048 pixels in the center portion can be read out and accordingly, the readout rate is doubled. FOV becomes half as compared to the full pixel read out. 2048 pixels are a fixed number and cannot be varied by the user.

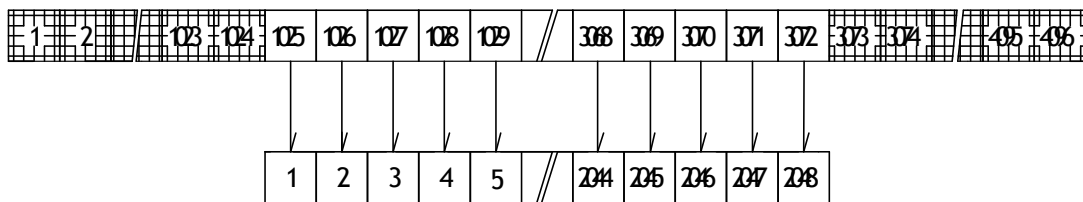

Fig.23 Windowing reads out only 2048 pixels at the center

6.3.14 Test pattern generator

LT-400CL has four test pattern generators.

In the following drawings, figures in shown in () are for 8 bits output.

Color bar

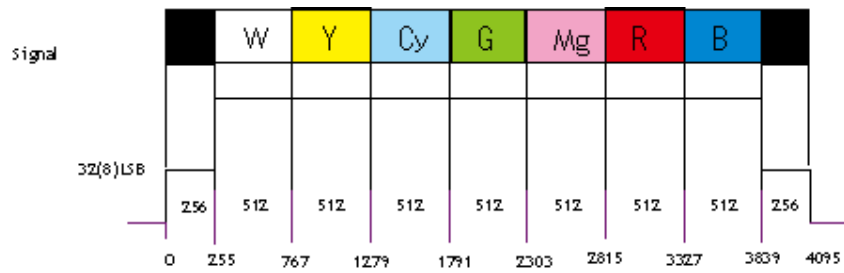

Fig.24 color bar test pattern

Gray 1

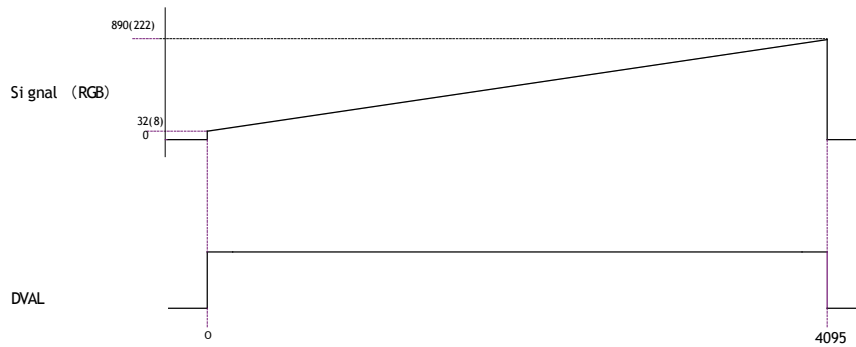

Fig.25 Gradation test pattern

Gray 2

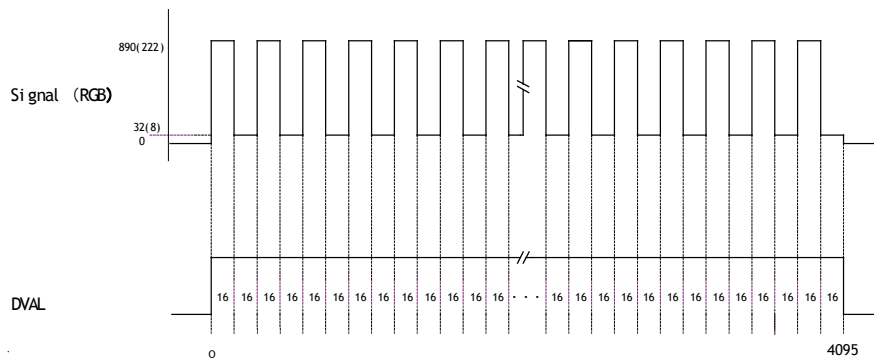

Fig.26 Multi burst test pattern

White

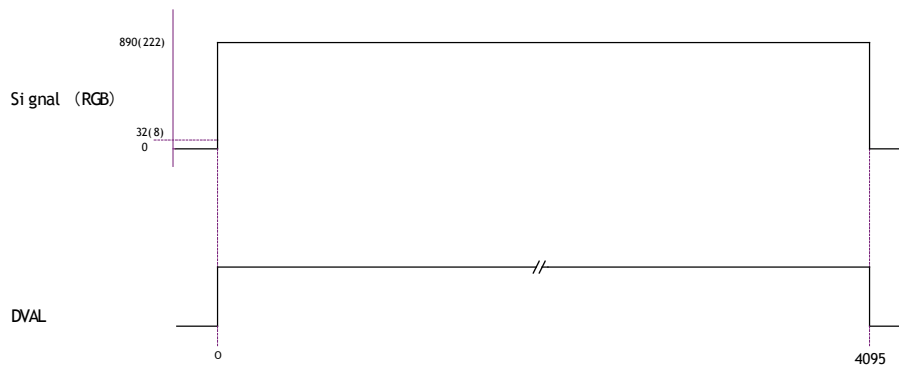

Fig.27 White test pattern

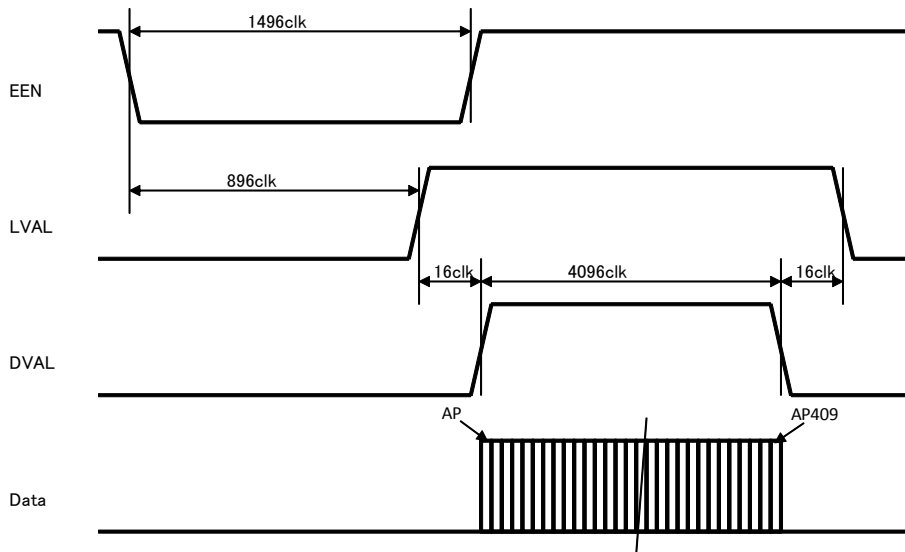

Fig.30 No-shutter / internal trigger mode

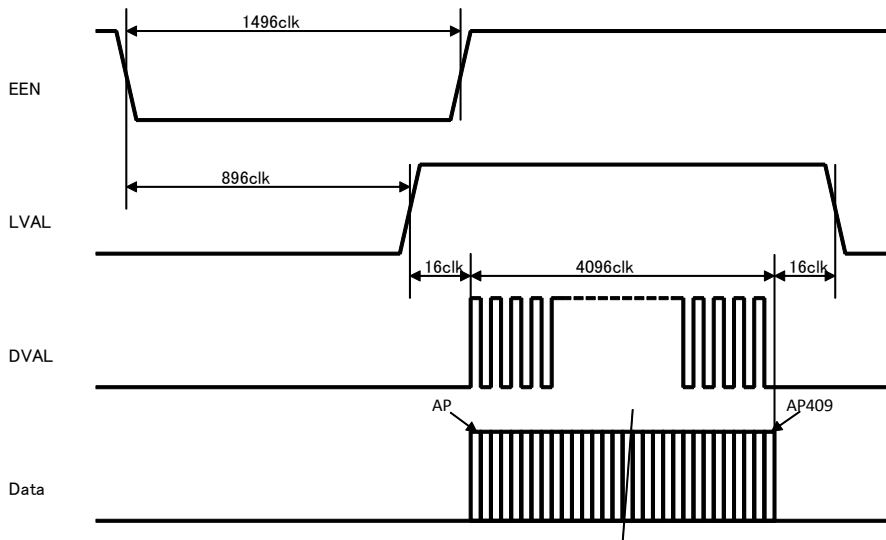

Fig.31 No-shutter mode / Binning / Internal

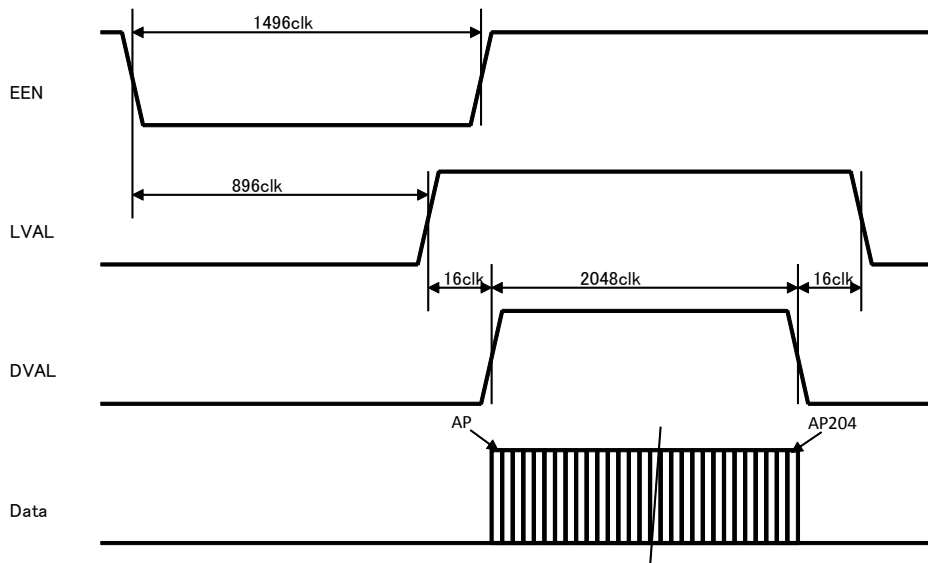

Fig.32 No-shutter /Sub-sampling and Window/ Internal

6.4.2 No-shutter mode with external trigger

In this mode, the exposure time is directly proportional to the line rate. The line rate is generated externally by a trigger signal. This mode is used when an external trigger signal is available, e.g. from an encoder, and the scan rate can be controlled by this signal. The camera can accept an external trigger through the Camera Link connector or through the 12-pin Hirose connector.

To use this mode:

Set function Trigger mode, No-shutterTR=0
 Trigger origin, external TG=1
 Trigger input TI=0 or 1

Important note:

- When the one-push white balance has been initiated and the rear panel LED shows orange, the camera must receive continuous external trigger pulses corresponding to the frequency and duty cycle used in the application.
- Minimum trigger interval

| Scan mode | Trigger input via | Minimum interval (µs) |
|------------------------|-------------------|-----------------------|
| Full/Binning | Camera link | 62.3 |
| | Hirose 12-pin | 66.8 |
| Sub-sampling/windowing | Camera link | 37.0 |
| | Hirose 12-pin | 41.5 |

- Minimum trigger pulse width

| Trigger input via | Minimum trigger pulse width |
|-------------------|-----------------------------|
| Camera link | 500 ns |
| Hirose 12-pin | 5µs |

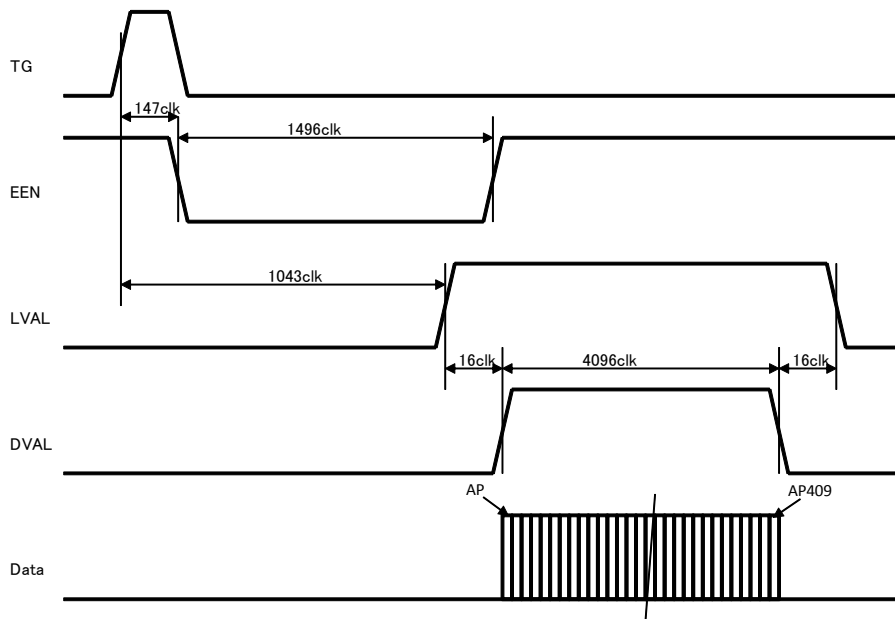

Fig. 33 No-shutter mode with external trigger

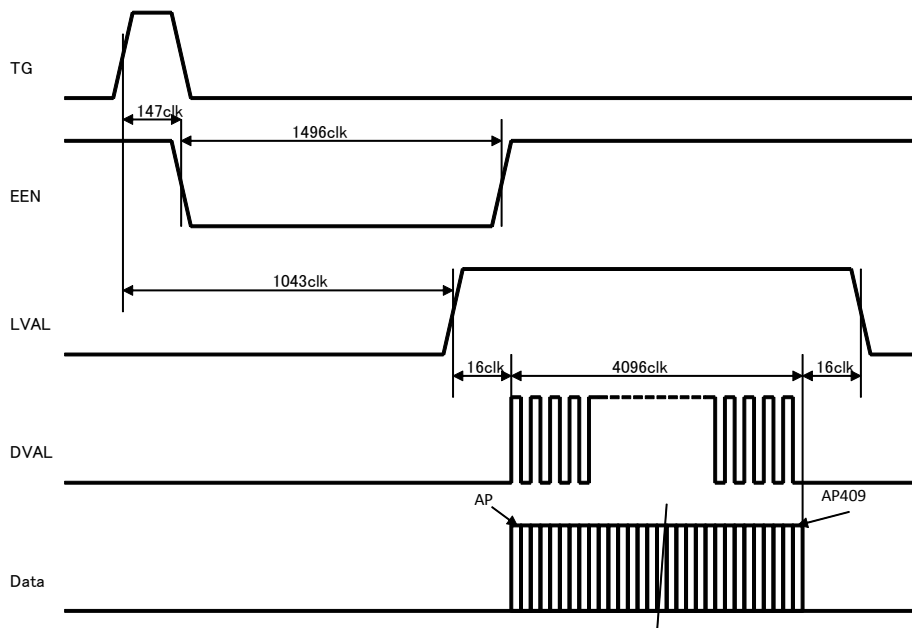

Fig. 34 No-shutter mode /Binning/ External

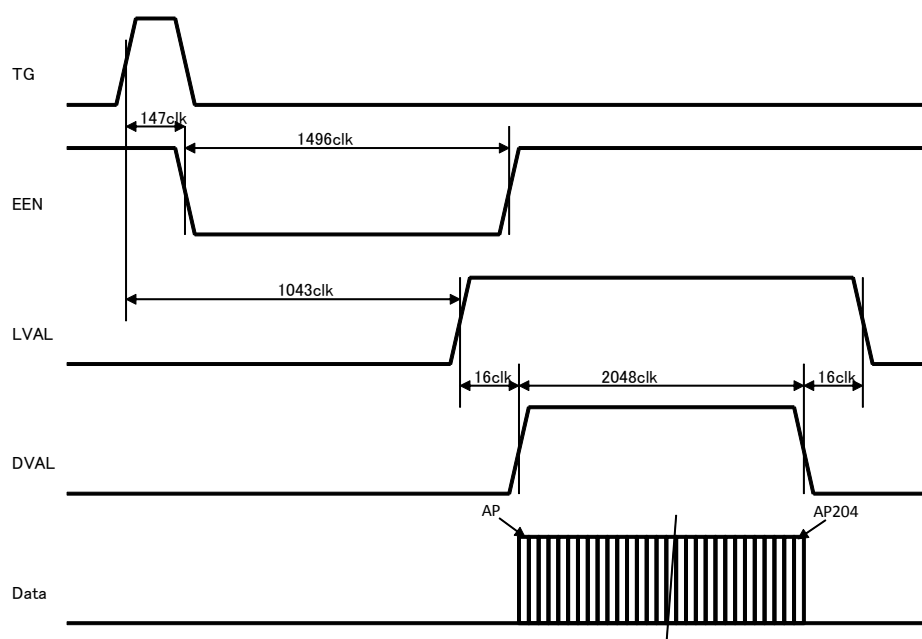

Fig.35 No-shutter mode /Sub-sampling and Window/ External

6.4.3 Shutter-select mode with internal trigger

This mode allows the user to have full control of the line rate and the exposure time individually, by programming separate timing generators. Subsequently the camera does not accept an external trigger signal in this mode.

To use this mode:

| | | |
|--------------|--------------------------------|---|
| Set function | Trigger mode, Shutter-select | TR=1 |
| | Line rate | LR=61.8 μ s to 15.02ms |
| | Trigger origin, internal | TG=0 |
| | Individual R, G and B exposure | EI=0(individual) EI=1(tracking with G) |
| | Programmable exposure | PER/PEG/PEB=4800 to 1194752 (60 μ s to 14.9ms in 12.5ns steps) |

Important note:

- If using individual exposure, the EEN signal represents the channel with the longest exposure time
- The maximum exposure time is the line rate setting.
- For one-push white balance, both shutter gain (AH) and gain(AW) are effective.

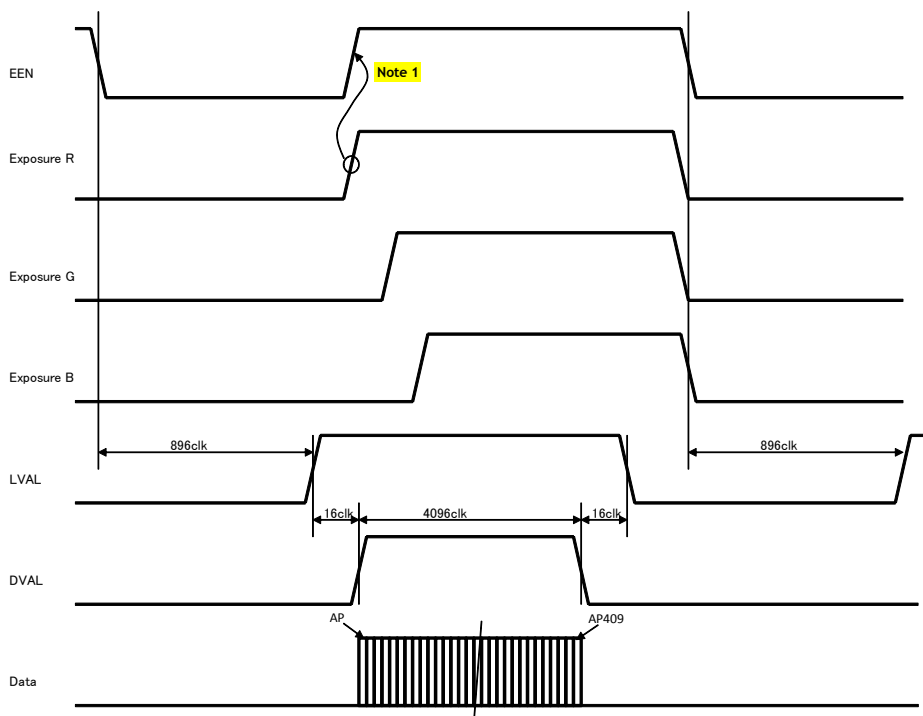

Note: EEN is used a channel with the largest exposure value

Fig. 36 Shutter-select mode with internal line rate generator (and individual exposure)

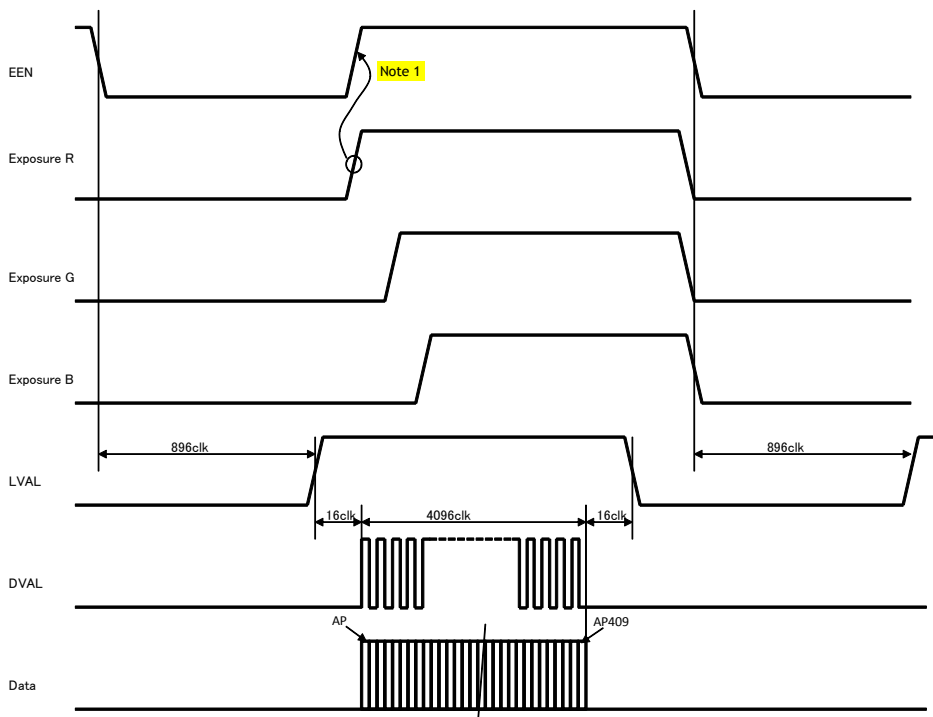

Note: EEN is used a channel with the largest exposure value

Fig.37 Shutter-select mode /Binning/ Internal

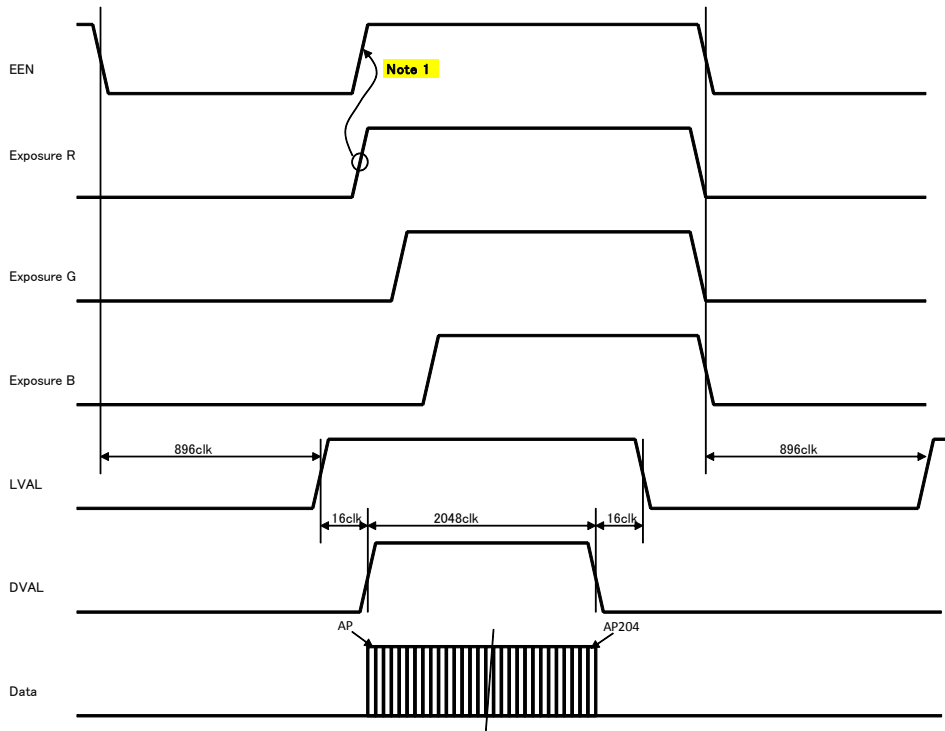

Note: EEN is used a channel with the largest exposure value

Fig.38 Shutter -select mode/Sub-sampling and Window/ Internal

6.4.4 Shutter-select mode with external trigger

This mode allows the user to have full control of the exposure time, by programming a timing generator, while the line rate is controlled by an external trigger signal. The camera can accept an external trigger through the Camera Link connector or through the 12-pin Hirose connector.

To use this mode:

| | | |
|--------------|--------------------------------|---|
| Set function | Trigger | TR=1 |
| | Trigger origin, external | TG=1 |
| | Individual R, G and B exposure | EI=0(individual) EI=1(tracking with G) |
| | Programmable exposure | PER/PEG/PEB=4800 to 1194752 (60µs to 14.9ms in 12.5ns steps) |

Important note:

- If using individual exposure, the EEN signal represents the channel with the longest exposure time
- The minimum trigger interval

| Scan mode | Trigger input via | Minimum interval (µs) |
|------------------------|-------------------|-----------------------|
| Full/Binning | Camera link | 62.3 |
| | Hirose 12-pin | 66.8 |
| Sub-sampling/windowing | Camera link | 37.0 |
| | Hirose 12-pin | 41.5 |

- The minimum trigger pulse width

| Trigger input via | Minimum trigger pulse width |
|-------------------|-----------------------------|
| Camera link | 500 ns |
| Hirose 12-pin | 5 μ s |

- The maximum exposure time is the line rate.
- When the one-push white balance has been initiated and the rear panel LED shows orange, the camera must receive continuous external trigger pulses corresponding to the frequency and duty cycle used in the application.

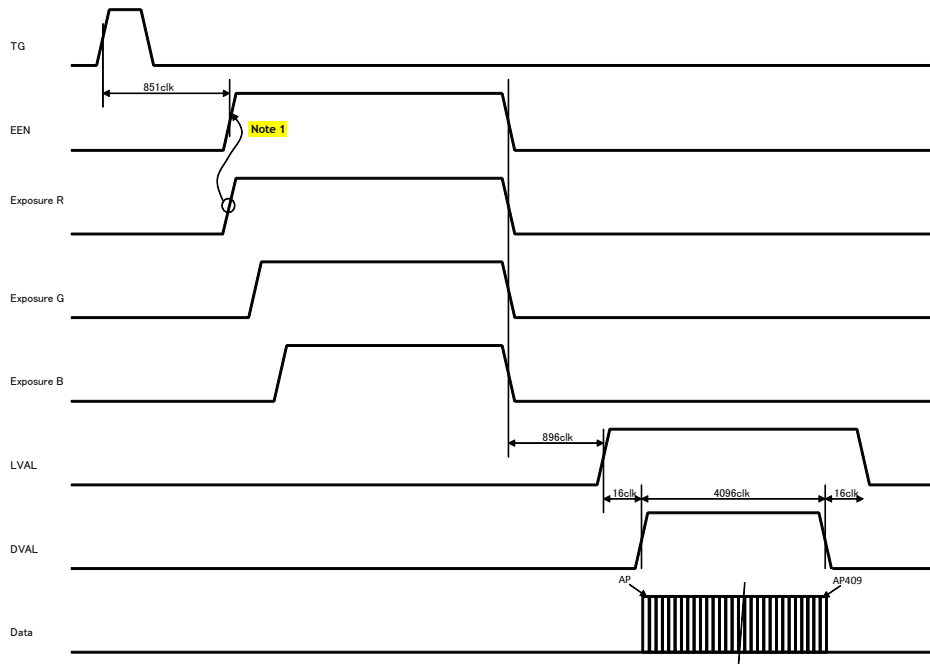

Note: EEN is used a channel with the largest exposure value

Fig. 39 Shutter-select mode with external trigger (and individual exposure)

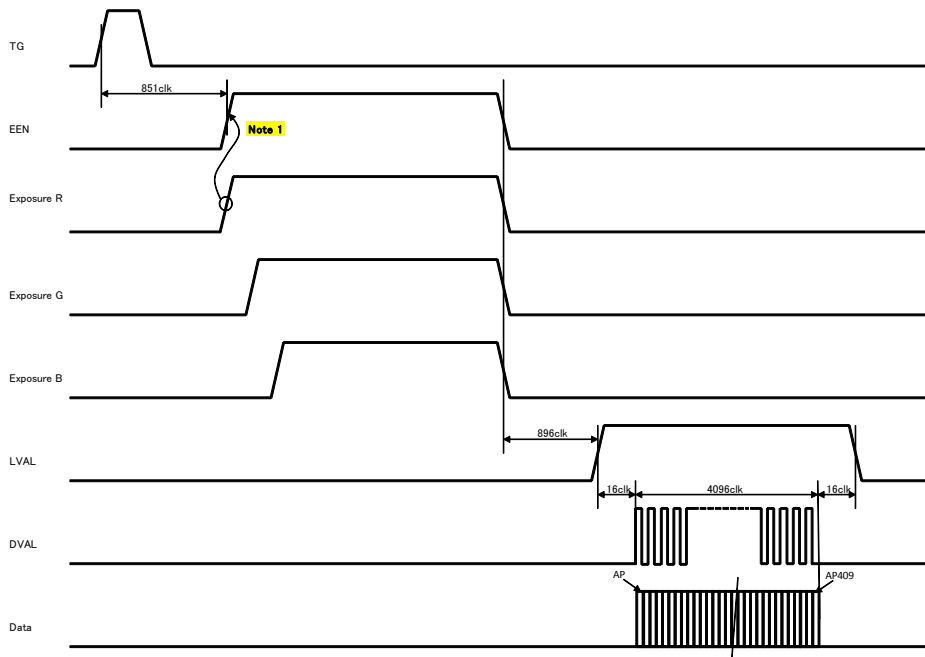

Note: EEN is used a channel with the largest exposure value

Fig.40 Shutter select mode /Binning /External

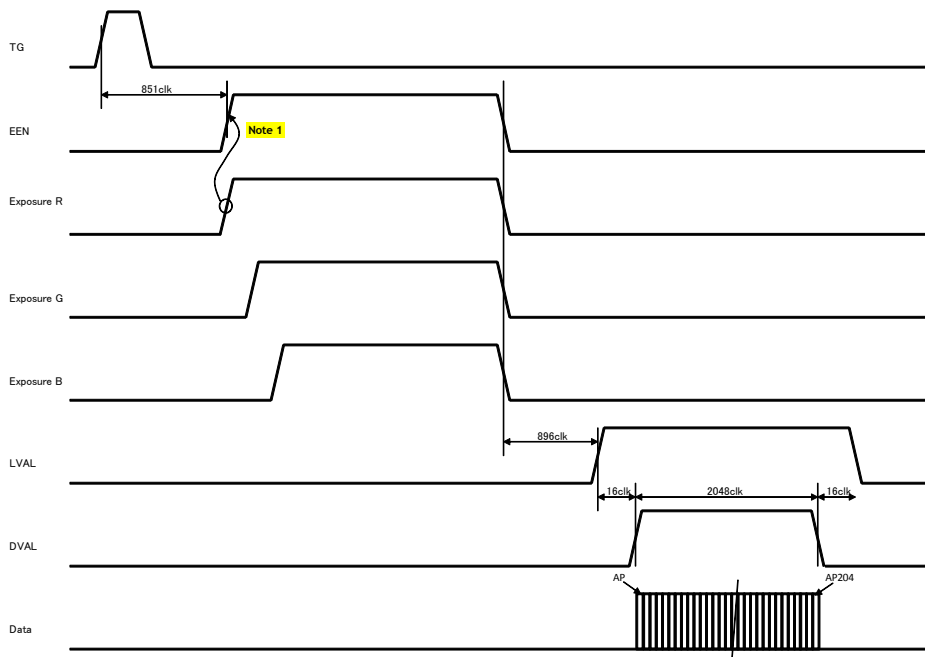

Note: EEN is used a channel with the largest exposure value

Fig.41 Shutter-select /Sub-sampling and Window/ External

6.4.5 Pulse Width Control (PWC) mode

In this mode, the user has full control of both the line rate and the exposure time of each line via the External Trigger input.

At the rising edge of the External Trigger signal, the exposure is initiated, and at the falling edge the exposure is terminated and read out. The camera can accept an external trigger through the Camera Link connector or through the 12-pin Hirose connector.

To use this mode:

Set function Trigger mode, PWC TR=2

Important Note:

- The minimum trigger interval

| Scan mode | Trigger input via | Minimum interval (μs) |
|------------------------|-------------------|------------------------------------|
| Full/Binning | Camera link | Exposure time + 62.3 |
| | Hirose 12-pin | Exposure time + 66.8 |
| Sub-sampling/windowing | Camera link | Exposure time + 37.0 |
| | Hirose 12-pin | Exposure time + 41.5 |

- The minimum trigger pulse width

| Trigger input via | Minimum trigger pulse width |
|-------------------|-----------------------------|
| Camera link | 67.57 μs |
| Hirose 12-pin | 67.57 μs |

- One-push white balance by gain setting only.
- When the one-push white balance has been initiated and the rear panel LED shows orange, the camera must receive continuous external trigger pulses corresponding to the frequency and duty cycle used in the application.

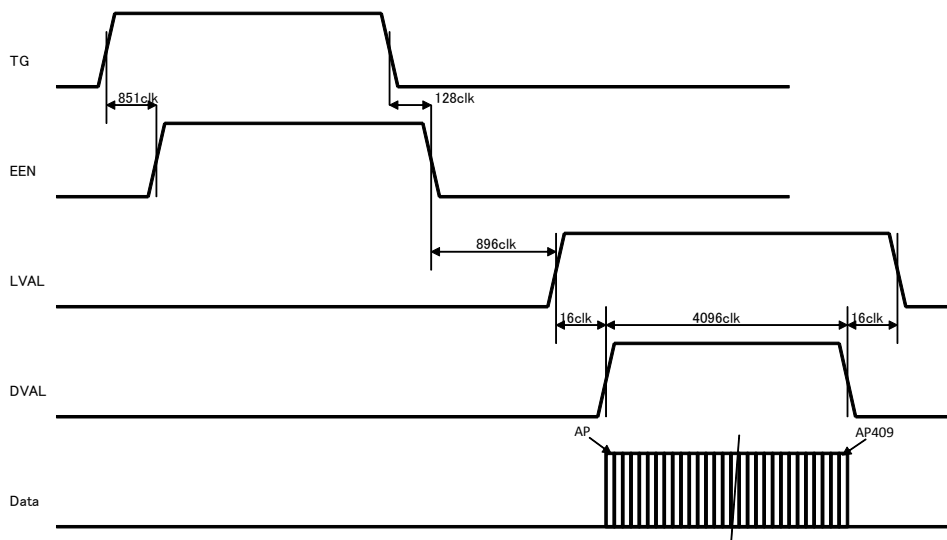

Fig. 42 Pulse Width Control mode

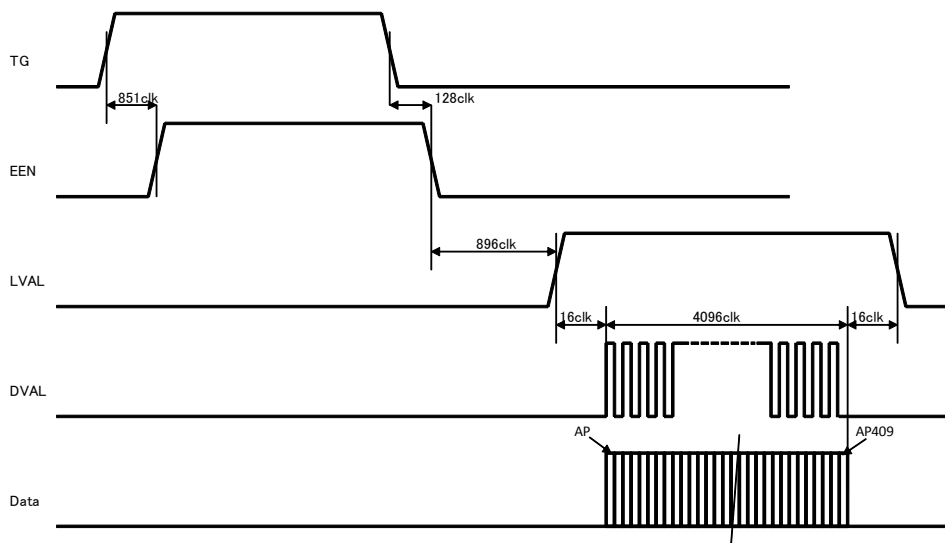

Fig.43 PWC mode /Binning

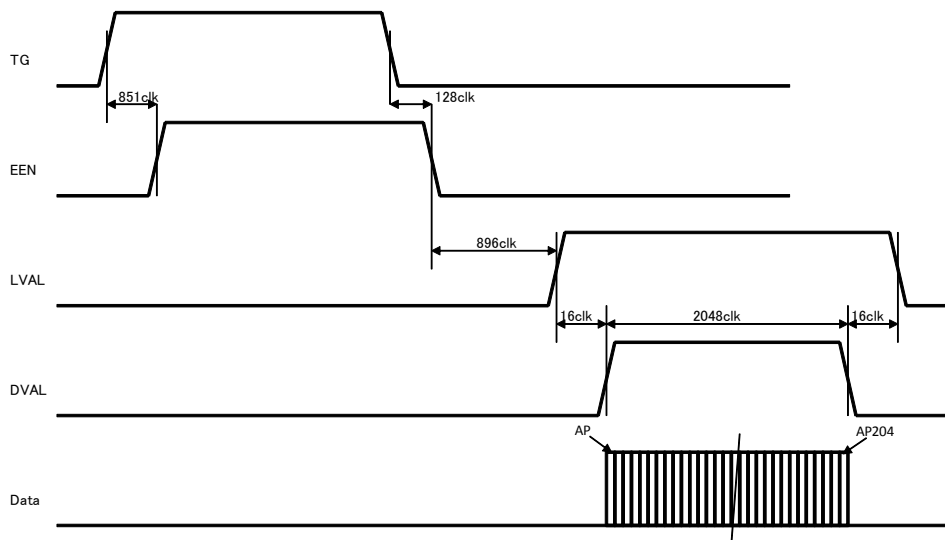

Fig.44 PWC mode /Sub-sampling and Window

6.4.6 Compatibility of trigger modes and functions

| Trigger | | Image output format | | | | Gain | | Offset | |
|----------------|----------|---------------------|---------|--------------|-----------|----------|-----------|-----------------|------------|
| Mode | Origin | Full resolution | Binning | Sub sampling | Windowing | Gain Low | Gain High | Master tracking | Individual |
| No-Shutter | Internal | ⊙ | ⊙ | ⊙ | ⊙ | ⊙ | ⊙ | ⊙ | ⊙ |
| | External | ⊙ | ⊙ | ⊙ | ⊙ | ⊙ | ⊙ | ⊙ | ⊙ |
| Shutter select | Internal | ⊙ | ⊙ | ⊙ | ⊙ | ⊙ | ⊙ | ⊙ | ⊙ |
| | External | ⊙ | ⊙ | ⊙ | ⊙ | ⊙ | ⊙ | ⊙ | ⊙ |
| PWC | External | ⊙ | ⊙ | ⊙ | ⊙ | ⊙ | ⊙ | ⊙ | ⊙ |

| Trigger | | Shading correction | | AWB | | Test pattern | Auto Line Rate |
|----------------|----------|--------------------|-------|------|---------|--------------|----------------|
| Mode | Origin | FLAT | COLOR | Gain | Shutter | | |
| No-Shutter | Internal | ⊙ | ⊙ | ⊙ | × | ⊙ | ⊙ |
| | External | ○ | ○ | ○ | | ○ | × |
| Shutter select | Internal | ⊙ | ⊙ | ⊙ | ⊙ | ⊙ | ⊙ |
| | External | ○ | ○ | ○ | ○ | ○ | × |
| PWC | External | ○ | ○ | ○ | × | ○ | × |

Note: ⊙ They can be used together.

○ They can be used together but when the compensation data is acquiring or test signal is displaying, the trigger pulse should be continuously input.

× They cannot be used together.

7. Configuring the camera

All the modes and functions of this camera are controlled by serial communication, via the Camera Link connector or via RS-232C on the Hirose 12-pin connector.

Chapter 7.1 shows the complete list of ASCII commands. Chapter 7.2 describes the commands in detail, in alphabetical order (sorted by the command acronym)

7.1. RS-232C control

All configuration of the LT-400CL camera is done via the RS-232C port on the 12-pin HR connector or via Camera Link. The camera can be set up from a PC running terminal emulator software, or using JAI's camera control software.

Below is the description of the ASCII based short command protocol.

Communication setting

| | |
|------------------|----------|
| Baud Rate | 9600 bps |
| Data Length | 8 bit |
| Start Bit | 1 bit |
| Stop Bit | 1 bit |
| Parity | None |
| Xon/Xoff Control | None |

RS 232C cable

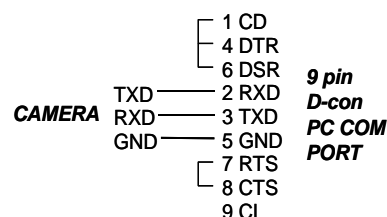

Note: Baud rate is available for 9600bps, 19200bps, 38400bps, 57600bps and 115200bps.

Protocol.

Transmit setting to camera:

NN=[Parameter]<CR><LF> (NN is any kind of command. Capital or small letters.)

The camera answers:

COMPLETE<CR><LF>

To have all communication visible on the emulator screen, start with:

EB=1<CR><LF>

The camera answers:

COMPLETE<CR><LF>

Transmit request command to camera:

NN?<CR><LF> (NN is any kind of command.)

The camera answers:

NN=[Parameter]<CR><LF>

Transmit the following to have the camera actual setting:

ST?<CR><LF>

The camera answers:

A complete list of the current settings

Transmit the following to have a command list:

HP?<CR><LF>

The camera answers:

A list with all commands and possible settings

Invalid parameters sent to camera: (99 is an invalid parameter)

SH=99<CR><LF>

The camera answers:

02 Bad Parameters!!<CR><LF>

To see firmware number.

VN?<CR><LF>

To see camera ID. It shows the manufacturing lot number.

ID?<CR><LF>

7.2. LT-400CL Command list

| | Command Name | Format | Parameter | Remarks |
|--|----------------------------------|--|---|--|
| A - General settings and useful commands. | | | | |
| 1 | Echo Back | EB=[Param.]<CR><LF> EB?<CR><LF> | 0=Echo off, 1=Echo on | Off at power up |
| 2 | Camera Status Request | ST?<CR><LF> | | Actual setting |
| 3 | Online Help Request | HP?<CR><LF> | | Command list |
| 4 | Firmware Program Version Request | VN?<CR><LF> | | 3 digits (e.g.) 100 = Version 1.00 |
| 5 | FPGA Program Version Request | PV?<CR><LF> | | 3 digits (e.g.) 100 = Version 1.00 |
| 6 | Camera ID Request | ID?<CR><LF> | | max 10 characters |
| 7 | Model Name Request | MD?<CR><LF> | | max 10 characters |
| 8 | User ID | UD=[Param.]<CR><LF> UD?<CR><LF> | | User can save and load free text.(16 or less characters) |
| B - Trigger mode | | | | |
| 1 | Trigger Mode | TR=[Param.]<CR><LF> TR?<CR><LF> | 0=No-shutter 1=Shutter select 2=Pulse width control | |
| 2 | Trigger Origin | TG=[Param.]<CR><LF> TG?<CR><LF> | 0=Internal 1=External | TG=0 is available when TR=0 or TR=1 |
| 3 | Trigger Input | TI=[Param.]<CR><LF> TI?<CR><LF> | 0=Camera-Link 1=Hirose12pin | |
| 4 | Trigger Polarity | TP=[Param.]<CR><LF> TP?<CR><LF> | 0=Active-Low 1=Active-High | |
| 5 | Auto Reset Mode | ARST=[Param.]<CR><LF> F> ARST?<CR><LF> | 0=OFF 1=ON | |

| C - Line Rate, Exposure | | | | |
|-------------------------|---|---|--|---------------------|
| 1 | Line Rate | LR=[Param.]<CR><LF> LR?<CR><LF> | Full resolution 4944 to 1201920 clocks Sub-sampling/window 2921 to 597376 clocks - 1 clock is 12.5ns | Available when TG=0 |
| 2 | One-push auto line rate set | AR=[Param.]<CR><LF> | 0=Activate one-push auto line rate set | Available when TG=0 |
| 3 | Auto line rate reference level | AL=[Param.]<CR><LF> AL?<CR><LF> | 0 to 1023 | At 10Bit |
| 4 | RB Exposure interlocked with G | EI=[Param.]<CR><LF> EI?<CR><LF> | 0=Off (independent) 1=On (interlocked) | Available when TR=1 |
| 5 | Programmable Exposure - Red | PER=[Param.]<CR><LF> PER?<CR><LF> | 4800 to 1194752clocks - 1 clock is 12.5ns | Available when TR=1 |
| 6 | Programmable Exposure - Green | PEG=[Param.]<CR><LF> > PEG?<CR><LF> | 4800 to 1194752clocks - 1 clock is 12.5ns | Available when TR=1 |
| 7 | Programmable Exposure - Blue | PEB=[Param.]<CR><LF> PEB?<CR><LF> | 4800 to 1194752clocks - 1 clock is 12.5ns | Available when TR=1 |
| 8 | One-push AWB shutter | AH=[Param.]<CR><LF> | 0=Activate one-push AWB shutter | Available when TR=1 |
| 9 | Inquire the status after one-push AWB shutter | AHRS?<CR><LF> | <One of following values will be replied from the camera> 0=AWB not finished yet. 1=Succeeded. 2=Error1 - G image was too bright. 3=Error2 - G image was too dark. 4=Error3 - Timeout-error occurred. | |
| D - Image format | | | | |
| 1 | Binning | BI=[Param.]<CR><LF> BI?<CR><LF> | 0=Binning Off, 1=Binning On | |
| 2 | Bit allocation | BA=[Param.]<CR><LF> BA?<CR><LF> | 0=24bit, 1=30bit | |
| 3 | Test Pattern | TS=[Param.]<CR><LF> TS?<CR><LF> | 0=Off 1=Color Bar 2=Gray Pattern 1 3=Gray Pattern 2 4=White | Off at power up |
| 4 | Sensor read out | SRO= [Param.]<CR><LF> SRO ? <CR><LF> | 0=off 1=Sub-sampling 2=Windowing | |

| E - Gain, white balance and signal settings | | | | |
|---|---------------------------------------|--------------------------------------|---|---------|
| 1 | Gain Level - Master | GA=[Param.]<CR><LF> GA?<CR><LF> | 0 to 800 (GM=0) -400 to 1400 (GM=1) | 100=1dB |
| 2 | Gain Level - Red | GAR=[Param.]<CR><LF> GAR?<CR><LF> | -400 to 600 (GM=0) -400 to 1400 (GM=1) | |
| 3 | Gain Level - Blue | GAB=[Param.]<CR><LF> GAB?<CR><LF> | -400 to 600 (GM=0) -400 to 1400 (GM=1) | |
| 4 | Gain Low / High - Red | SGR=[Param.]<CR><LF> SGR?<CR><LF> | 0=Low 1=High | |
| 5 | Gain Low / High - Green/Master | SGG=[Param.]<CR><LF> SGG?<CR><LF> | 0=Low 1=High | |
| 6 | Gain Low / High - Blue | SGB=[Param.]<CR><LF> SGB?<CR><LF> | 0=Low 1=High | |
| 7 | Gain Mode | GM=[Param.]<CR><LF> GM?<CR><LF> | 0=Master tracking 1=Individual | |
| 8 | White Balance | WB=[Param.]<CR><LF> WB?<CR><LF> | 0=Manual/One push AWB 1=4000K 2=4600K 3=5600K | |
| 9 | Activate One-push AWB | AW=[Param.]<CR><LF> | 0=Activate one-push AWB | |
| 10 | Inquire the status after one-push AWB | AWRS?<CR><LF> | <One of following values will be replied from the camera> 0=AWB has not been finished yet. 1=Succeeded. 2=Error1 - G image was too bright. 3=Error2 - G image was too dark. 4=Error3 - Timeout-error occurred. | |
| 11 | Noise reduction | NR [Param.]<CR><LF> NR ? <CR><LF> | 0=off 1=on | |
| 12 | Black Level - Master | BL=[Param.]<CR><LF> BL?<CR><LF> | 0 to 127 | |
| 13 | Black Level - Red | BLR=[Param.]<CR><LF> BLR?<CR><LF> | -64 to 63 | |
| 14 | Black Level - Blue | BLB=[Param.]<CR><LF> BLB?<CR><LF> | -64 to 63 | |
| 15 | Black Level mode | BLM=[Param.]<CR><LF> BLM?<CR><LF> | 0=Master Tracking 1=Individual | |
| 16 | Knee On/Off | KN=[Param.]<CR><LF> KN?<CR><LF> | 0=Off, 1=On | |
| 17 | Knee Slope - Red | KSR=[Param.]<CR><LF> | 0 to 65535 | |

| | | | | |
|--|--|---|--|------------------------|
| | | KSR?<CR><LF> | | |
| 18 | Knee Slope - Green | KSG=[Param.]<CR><LF> KSG?<CR><LF> | 0 to 65535 | |
| 19 | Knee Slope - Blue | KSB=[Param.]<CR><LF> KSB?<CR><LF> | 0 to 65535 | |
| 20 | Knee Point - Red | KPR=[Param.]<CR><LF> KPR?<CR><LF> | 0 to 1023 | |
| 21 | Knee Point - Green | KPG=[Param.]<CR><LF> KPG?<CR><LF> | 0 to 1023 | |
| 22 | Knee Point - Blue | KPB=[Param.]<CR><LF> KPB?<CR><LF> | 0 to 1023 | |
| F - Shading correction, pixel gain and pixel black correction | | | | |
| 1 | Select shading correction mode | SDC=[Param.]<CR><LF> SDC?<CR><LF> | 0=Off (Bypass) 1=Factory area 2=User area | |
| 2 | Run shading correction, store to user area | SDR=[Param.]<CR><LF> | 0=Run flat shading correction, store to user area 1=Run color shading correction, store to user area | Store in user setting. |
| 3 | Inquire the status after shading correction | SDS?<CR><LF> | 0=Shading correction has not been finished yet. 1=Succeeded. 2=Error1 - image was too bright. 3=Error2 - image was too dark. 4=Error3 - Timeout-error occurred. | |
| 4 | Select pixel gain correction mode | PGC=[Param.]<CR><LF> > PGC?<CR><LF> | 0=Off (Bypass) 1=Factory area 2=User area | |
| 5 | Run pixel gain correction, store to user area | PGR=[Param.]<CR><LF> > | 0=Run PRNU correction, store to user area 1=Run flat correction, store to user area | Store in user setting. |
| 6 | Inquire the status after pixel gain correction | PGS?<CR><LF> | 0=Pixel gain correction has not been finished yet. 1=Succeeded. 2=Error1 - image was too bright. 3=Error2 s too bright.n has no 4=Error3 - Timeout-error occurred. | |

| | | | | |
|--|---|--------------------------------------|---|---|
| 7 | Select pixel black correction mode | PBC=[Param.]<CR><LF> PBC?<CR><LF> | 0=Off (Bypass) 1=Factory area 2=User area | |
| 8 | Run pixel black correction, store to user area | PBR=[Param.]<CR><LF> | 0=Run pixel black correction, store to user area | Store in user setting. |
| 9 | Inquire the status after pixel black correction | PBS?<CR><LF> | 0=Pixel black correction has not been finished yet. 1=Succeeded. 2=Error1 - image was too bright. 3=Error2 - image was too dark. 4=Error3 - Timeout-error occurred. | |
| G - Saving and loading data in EEPROM | | | | |
| 1 | Load Settings (from Camera EEPROM) | LD=[Param.]<CR><LF> | 0=Factory area 1=User area1 2=User area2 | Latest used DATA AREA will become default at next power up. |
| 2 | Save Settings (to Camera EEPROM) | SA=[Param.]<CR><LF> | 1=User area1 2=User area2 Note the parameter 0 is not allowed. | |
| 3 | EEPROM Current Area No. Request. | EA?<CR><LF> | 0=Factory area 1=User area1 2=User area2 | The camera returns latest used DATA AREA. |

Note: To avoid malfunction, do not attempt writing commands not shown in the above list.

8. Functions listed alphabetically by command acronyms

8.1. Command **AH** - One-push AWB shutter

This command controls a white balance by setting an appropriate shutter speed for each channel.

Settings: 0 to initiate
 Applicable modes: TR=1 Shutter select mode
 Associated functions: Commands WB,EI,PER,PEG,PEB

Important Note:

- When color temperature of used illumination exceeds the range of adjustment, proper white balance may not be obtained.
- The data can be stored in camera memory for use at next start up.
- This function can work on external trigger mode.
- The S/N ratio of the output will remain constant for all channels

Refer to chapter [6.3.4 White balance](#) for further details.

8.2. Command **AHRS** - Request status after One-Push AWB

This command returns the status of the One-Push AWB function, with the following parameters:

0=AWB not completed yet
 1=Succeeded
 2=Error1: Green image too bright
 3=Error2: Green image too dark
 4=Error3: Timeout occurred

8.3. Command **AL** - Automatic Line Rate Reference Level

Settings: 0 to 1023(10 bit output)
 Applicable modes: No-Shutter with Internal trigger
 Shutter select with internal trigger
 Associated functions: Command AR

8.4. Command **AR** - Automatic Line Rate setting

This function will calculate and set the line rate of the camera based on the Automatic Line Rate Reference Level (as set in command AL) and the scene illumination. Please note that the aspect ratio of the scanned object will change as the line rate is changed.

Settings: 0 (activate automatic process)
 Applicable modes: No-Shutter with internal trigger
 Shutter select with internal trigger
 Associated functions: Command AL, Command TG=0

Important note

- The data can be stored in the camera memory for next start up.

8.5 Command **ARST** - Auto reset mode

In the no-shutter and external trigger mode, if the trigger is input after a long time interruption, more than 52msec , the over exposed signal during the trigger interruption is output after the first trigger. In this case, if ARST mode is ON, LAVL, DVAL and video signal are not output during the trigger interruption and LAVL, DVAL and video signal are output after the second trigger input. In the shutter select mode, the video signal is output with setting exposure time after the first trigger regardless of ASRT mode is On or OFF.

This function is OFF as the default setting.

ARST: 0=OFF

1=ON

8.6 Command **AW** - Activate One-push Auto White Balance (AWB) - Gain

By sending this command via the serial communication, the *gain based* One-Push AWB function is activated. This function can also be initiated by pressing the rear panel button. During this time the rear panel LED will show orange.

This function operates in two steps. First the Red-to-Green channel difference and the Blue-to-Green channel difference is calculated separately. Then the gain of the Blue and Red channel is automatically adjusted, to obtain the same output level on all three channels.

Settings: 0 = activate automatic process

Applicable modes: All

Associated functions: Command WB (WB=0), Rear panel One-push WB button.

Important Note:

- When color temperature of used illumination exceeds the range of adjustment, proper white balance may not be obtained.
- The data can be stored in camera memory for use at next start up.
- This function can work on external trigger mode.
- The S/N ratio of the output will change as a result of this function.

Refer to chapter [6.3.4 White balance](#) for further details.

8.7 Command **AWRS** - Inquire the status after one-push AWB

This command returns the status of the one-push AWB function, with the following parameters:

0=Shading correction not completed yet

1=Successful

2=Error 1 - Image was too bright

3=Error 2 - Image was too dark

4=Error 3 - Timeout occurred

8.8 Command **BA** - Bit Allocation

This function lets the user select whether the video data is presented as 3 x 8 (24)-bit or 3 x 10 (30)-bit on the Camera Link output. The internal processing in the camera is based on a 12 bit A/D signal. The 24-bit and 30-bit function removes the least significant bits from the 12 bit signal.

Settings: 0=24-bit, 1=30-bit
 Applicable modes: All

8.9 Command **BI** - Binning (Horizontal only)

This function reduces the number of pixels to 256 without affecting the line rate. Two adjacent pixels are combined at the output stage and read out as one pixel. Sensitivity is doubled as a result of binning. Refer to Chapter [6.3.11 Binning](#) for how it works.

Settings: 1=binning on, 0=binning off
 Applicable modes: All

Important Note:

- Setting data is stored in camera memory for use at next start up
- This function is available for all modes.

8.10 Command **BL** - Master Black Level

This command is a global black level adjustment for all channels. The adjustable range for master black is 0LSB to 64 (16) LSB. The number in parenthesis is valid for 24-bit output.

Settings: 0 to 127
 Associated functions: Command BLR - black level for the red channel.
 Command BLB - black level for the blue channel.

8.11 Commands **BLR** and **BLB** - Black level red and black level blue

In conjunction with Command BL, these commands allow individual setting of the black level in all channels.

Settings: -64 to 63
 Associated functions: Command BL

Refer to [chapter 6.3.6](#) for further details.

8.12 Command **BLM** - Black level mode

Select the master tracking mode or the individual mode.

Settings: 0=Master tracking, 1= Individual

8.13 Command **EI** - Interlocked R and B exposure with G

When this function enabled (interlocked), exposure time for R and B channels is interlocked with that of G channel. The Red and Blue channels will track the Green channel proportionally, thus maintaining white balance settings. When this is OFF, all channels are adjusted independently.

Settings: 0= OFF (independent R, G and B settings)
 1= ON(R and B channels interlocked with G channel)

Applicable modes: TR=1 Shutter-select mode only
 Associated functions: Commands PER, PEG, PEB - Programmable Exposure

Refer to [6.3.2 Electronic shutter \(Exposure\)\(Command PER,PEG,PEB\)](#) for further details.

8.14 Command GA - Gain level master / G channel

Adjust the master gain or G channel gain in accordance with gain mode (GM).

GM=0 Master tracking Adjust as master gain
 Adjusting range is 0 to 800

GM=1 Individual gain Adjust for G channel
 Adjusting range is -400 to 1400

8.15 Commands GAR and GAB - Red and blue gain levels

In conjunction with the Command SGR, SGG and SGB, Gain Low or Gain High this function allows the individual setting of gain for all channels. It is important to note that increasing the gain will lead to an increased noise level and reduced S/N-Ratio.

Settings: -400 to 600 (where 100 equals 1dB) (GM=0)
 -400 to 1400 (where 100 equals 1dB) (GM=1)

Associated function: Commands SGR, SGG, SGB, GM

Applicable modes: All modes

Refer to chapter [6.3.5 Gain control](#) for further details.

8.16 Command GM - Gain mode

This command sets the master tracking mode or the individual mode.

GM=0 Master tracking

GM=1 Individual mode

8.17 Command KN - Knee ON/Off

This command activated Knee correction function.

Settings: 0=OFF, 1=ON

8.18 Commands KSR, KSG and KSB - Knee slope for R, G and B

See command KN for description of this function

Settings: 0 to 65535

Associated functions Command KN, Commands KPR, KPG and KPB

8.19 Commands KPR, KPG and KPB - Knee point for R, G and B

See command KN for description of this function

Settings: 0 to 1023

Associated functions: Command KN, Commands KSR, KSG and KSB

Refer to chapter [6.3.7 Knee correction](#) for further details.

8.20 Command LR - Line Rate (Scan Rate)

This function is used only when there is no external trigger pulse (e.g. from an encoder) available. It allows the user to program the line rate, in order to match the speed of the object being scanned. In the No-Shutter mode, the exposure time is directly proportional to the line rate ($T_{exp} = 1/\text{line rate}$)

Settings: 4944 to 1201920, 61.8 μ s to 15.02ms in 12.5ns increments
 Associated functions: Trigger origin, TG=0
 Applicable modes: No-Shutter with internal line rate generator (TR=0)
 Shutter-Select with internal line rate generator (TR=1)

Important note

- The data can be stored in the camera memory for next start up.

Refer to chapter [6.3.1 Line rate \(Command LR\)](#) for further details

8.21 Command NR - Noise reduction

This command activates noise reduction circuit.

Settings: 0=OFF, 1=ON

8.22 Command PBC - Select pixel black correction mode

This command enables (or disables) the “pixel black level” correction function, which compensates for Dark Signal Non Uniformity (DSNU / FPN) for individual pixels.

Settings: 0 = Off (Bypass)
 1 = Factory setting
 2 = user area

Associated functions: Command PBR

Applicable modes: All

8.23 Command PBR - Run pixel black correction and store to user area

This command initiates the “pixel black level” correction function, and stores the settings in the user area. When this function is activated, lens must be capped.

Settings: 0 = Run this function

Associated functions: Command PBC must be set to 2

Important note:

- This function requires that no light reaches the image sensors. The lens must therefore be covered by a lens cap, or put the F-mount protective cover on the camera, when executing this function.
- As the black level is influenced by the exposure time (especially for long exposure time, at slow scan rates) it is recommended to perform the pixel black correction at the exposure time and line rate at which the camera will be operated.

8.24 Command PBS - Inquire the status of after pixel black correction

This command returns the status of the pixel black correction, with the following parameters:

- 0=Shading correction not completed yet
- 1=Successful
- 2=Error 1 - Image was too bright
- 3=Error 2 - Image was too dark
- 4=Error 3 - Timeout occurred

8.25 Command PER - Programmable exposure - Red

This command allows individual setting of the exposure time of the Red channel. It is only valid for the Shutter select mode.

- Settings: 4800 to 1194752 clocks,
60 μ s to 14.9ms in 12.5ns steps
- Applicable mode: TR=1 Shutter select mode
- Associated functions: EI (R and G exposure interlocked with G)

8.26 Command PEG - Programmable exposure - Green

This command allows individual setting of the exposure time of the Green channel. It is only valid for the Shutter select mode.

- Settings: 4800 to 1194752 clocks,
60 μ s to 14.9ms in 12.5ns steps
- Applicable mode: TR=1 Shutter select mode
- Associated functions: EI (R and G exposure interlocked with G)

8.27 Command PEB - Programmable exposure - Blue

This command allows individual setting of the exposure time of the Blue channel. It is only valid for the Shutter select mode.

- Settings: 4800 to 1194752 clocks,
60 μ s to 14.9 ms in 12.5ns steps
- Applicable mode: TR=1 Shutter select mode
- Associated functions: EI (R and G exposure interlocked with G)

Refer to chapter [6.3.2 Electronic shutter \(Exposure\)](#) for further details.

8.28 Command PGC - Pixel gain correction mode

This command enables (or disables) the “pixel gain” (flat-field) correction function, which compensates for Pixel Response Non Uniformity (PRNU) for individual pixels.

- Settings: 0=Off (Bypass)
1=Factory Setting (default)
2=User area
- Associated functions: Command PGR
- Applicable modes: All

8.29 Command PGR - Run pixel gain correction and store in user area

This command initiates the flat-field correction function, and stores the settings in the user area.

Settings: 0= Run PRNU correction and store to user area
 1= Run flat correction and store to user area

Associated functions: Command PGC must be set to 2

Important note:

- The image sensors must not be saturated when executing this function.
- When executing this function, the exposure time and line rate should be the same as when the camera is operated in the application.

Refer to chapter [6.3.8 PRNU \(Pixel Response Non-Uniformity\) correction](#) for further details.

8.30 Command PGS - Inquire the status after pixel gain correction

This command returns the status of the pixel gain correction, with the following parameters:

- 0=Shading correction not completed yet
- 1=Successful
- 2=Error 1 - Image was too bright
- 3=Error 2 - Image was too dark
- 4=Error 3 - Timeout occurred

8.31 Command SDC - Select shading correction mode

This function enables (or disables) the shading correction.

Settings: 0 = off (Bypass)
 1 = Factory setting (default)
 2 = User area

Associated functions: Command SDR

8.32 Command SDR - Run shading correction

This function initiates automatic shading correction, and stores the result to the user area. This function should be used together with the flat-field correction (commands PGC and PGR). There are two types of shading correction: Individual R, G and B channel correction and chromatic shading correction.

Settings: 0=Run flat shading correction and store to user area
 1=Run color shading correction and store to user area

(A) Flat shading correction (SDR=0)

Shading is calculated and individually compensated for R, G and B channels respectively. The calculation is based on the average value of 8 consecutive pixels. The maximum deviation that can be compensated is -20% of the highest signal level (brightness) of the line.

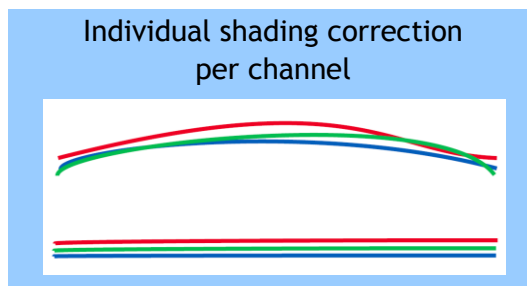

Important note:

- Depending on the optics and/or illumination used together with the camera, it may not be possible to fully compensate for shading.

Operating procedure for individual R, G and B channel shadings correction:

1. Before making adjustment, approximately 30 minutes warming up is required.
2. Make sure the output signal is not saturated (80% of full output is recommended)
3. Set command PGC=2 and SDC=2.
4. Set command SDR to 0 to initiate shading correction.
5. If desired, set command PGR to 0 to activate pixel gain correction to correct for pixel response non-uniformity.
6. Again set SDR=0 after running the pixel gain correction

(B) Color shading correction (SDR=1)

In this mode, shading correction of R and B signals is referenced to the G signal which is the reference. When the Green channel detects “undulating” or “parabolic” type shading, R and B channels are compensated to follow the same curve.

The calculation is based on the average value of 8 consecutive pixels

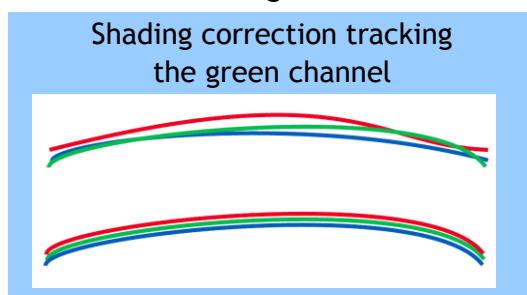

Important Note:

- For this function, no reference value is stored in the camera.

Operating procedure for color shadings correction:

1. Before making adjustment, approximately 30 minutes warming up is required.
2. Make sure the output signal is not saturated (80% of full output is recommended)
3. Set command PGC=2 and SDC=2.

4. Set command SDR to 1 to initiate shading correction.
5. If desired, set command PGR to 0 to activate flat-field (pixel gain) correction to correct for pixel response non-uniformity.
6. Again set SDR=1 after running the flat-field (pixel gain) correction

Refer to chapter [6.3.10 Shading correction](#) for further details.

8.33 Command **SDS** - Request status after executing shading correction command

This command returns the status of the shading correction function, with the following parameters:

0=Shading correction not completed yet

1=Successful

2=Error 1 - Image was too bright

3=Error 2 - Image was too dark

4=Error 3 - Timeout occurred

8.34 Commands **SGR,SGG,SGB** - Gain Low, High

These commands select the reference level, low or high for red, green and blue.

Settings 0=Low
 1=High

Refer to chapter [6.3.5 Gain control](#) for further details.

8.35 Command **SRO** - Sensor read out

This command selects output format.

Settings: 0=OFF
 1=Sub-sampling
 2=Windowing

Refer to chapter [6.3.12 Sub-sampling](#) and [6.3.13 Windowing](#) for how they work.

8.36 Command **TG** - Trigger Origin

Selects whether an external signal or an internal clock generator is used as a trigger source.

Settings: 0=Internal clock generator
 1=External signal

Associated commands: TI,TP

8.37 Command **TI** - Trigger input

Selects whether the External Trigger input signal is taken from the Camera Link connector, or from the 12-pin Hirose connector.

Settings: 0=Camera Link connector
 1=12-pin Hirose connector

8.38 Command **TP** - Trigger polarity

Settings: 0=Active Low (factory default)
 1=Active High

8.39 Command **TR** - Trigger Mode

Selects the trigger mode of the camera. Depending on the mode used, it allows the scan rate to either be programmed by an internal timing generator or by an external trigger pulse.

Settings: 0=No-Shutter mode
 1=Shutter-Select mode
 2=Pulse Width Control (PWC) mode
Associated functions: Command TG (trigger origin)
 Command TI (trigger input)
 Command TP (trigger polarity)

8.40 Command **TS** - Test pattern

This allows the camera to output a number of test patterns for set-up and troubleshooting.

Settings: 0=off
 1=Color bar
 2=Gray wedge
 3=Gray bars
 4=White (890LSB)

Refer to chapter [6.3.14 Test pattern generator](#) for further details.

8.41 Command **WB** - White Balance

The white balance function can be used for manual setting, One-Push automatic white balance (AWB) and fixed color temperatures (3 selections)

Settings: 0=Manual / On-Push AWB
 1=4000K
 2=4600K
 3=5600K
Applicable modes: All
Associated functions: Command AW (Gain)

Refer to chapter [6.3.4 White balance](#) for further details.

9. Camera Control Tool for LT-400CL

A Camera Control Tool for Windows XP/Vista/7 can be downloaded from www.jai.com.

9.1. Software Install

Execute LT-400CL_Ver.XXX.exe in the downloaded file. The setup program starts and continues according to the screen instructions.

9.2. Open the Control Tool

Connect the camera to the PC on which the software is installed and set the power ON. Then select “All programs” in the Windows start menu, select “JAI A-S” and click “LT-400CL control tool”. LT-400CL Camera Control Tool and Communication windows will open.

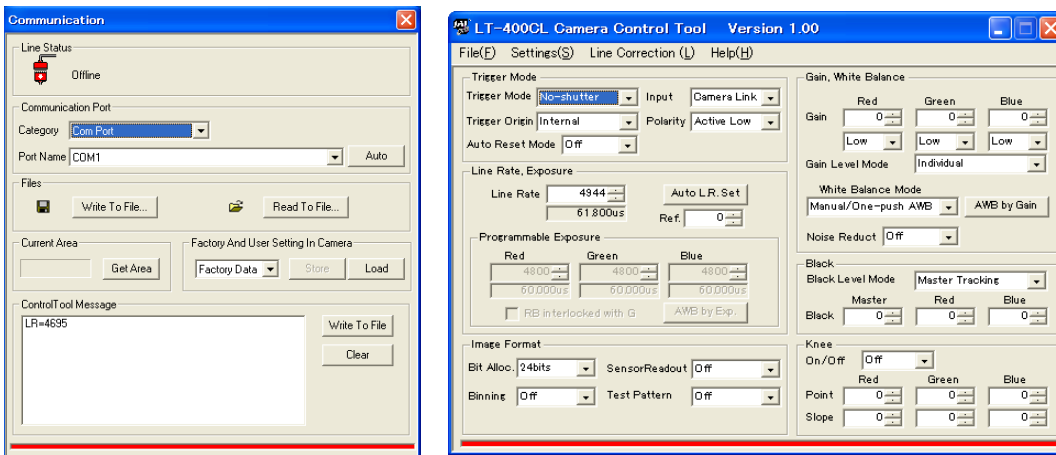

If the Communication window does not open, click “Help” in the Download menu of “Camera Control Tool” and click “Communication”.



9.3. Connect a camera

If the frame grabber board is already installed in the connected PC, it will appear in the “Category” box in the “Communication port” pane. Click it if it is the appropriate one.

If the frame grabber board is not used, select the COM port to which the camera is connected, and click “OK”. After the connection is established, the RED Off-line icon changes to GREEN and the RED bar in the bottom changes to GREEN.



9.4. Camera control window

When the connection between camera and PC is completed, the camera control tool shows the current camera settings.

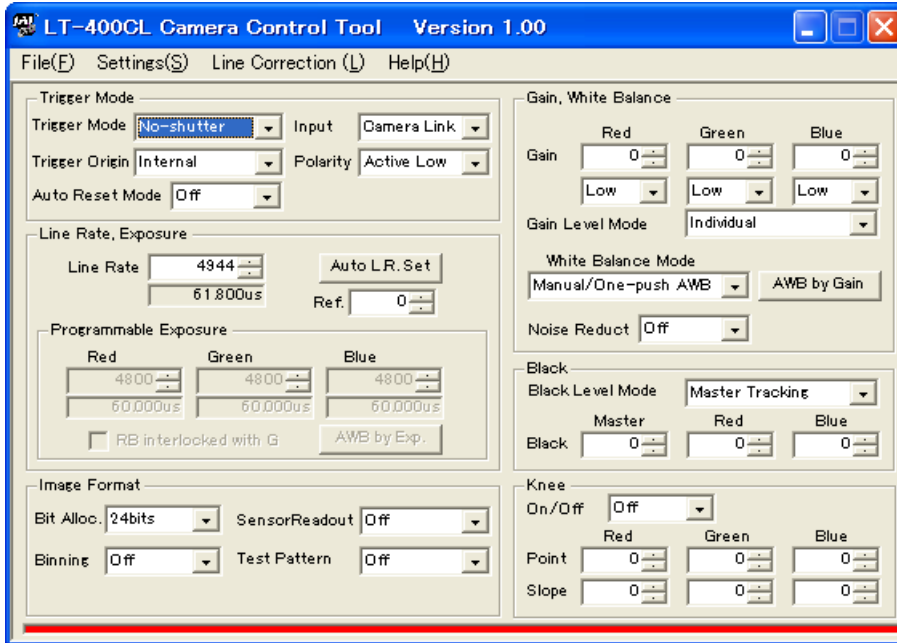

9.5. Menu

9.5.1 File menu

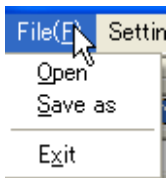

- Open: Transfer the setting parameters in HDD or other memory devices to the camera. The extension is .cam
- Save as: Store the setting parameters to HDD or other memory devices. The extension is .cam.
- Exit: Finish the software.

9.5.2 Settings menu

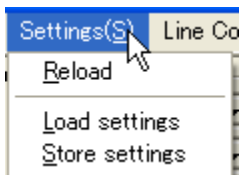

- Reload: Read the setting parameters from RAM area of the camera.
- Load settings: Read the setting parameters from EEPROM area of the camera. Select from Factory, User 1 or User 2.
- Store settings: Store the parameters in the EEPROM area of the camera. Select from User 1 or User 2.

9.5.3 Line Correction menu

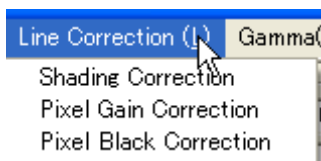

Click Line Correction menu and a drop-down menu will open. The setting window for shading, pixel gain and pixel black can be opened.

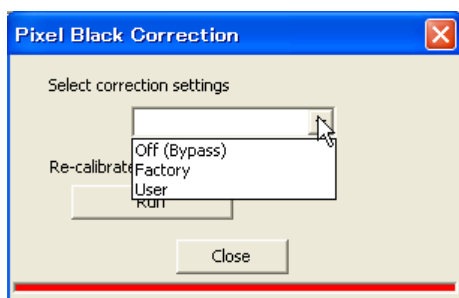
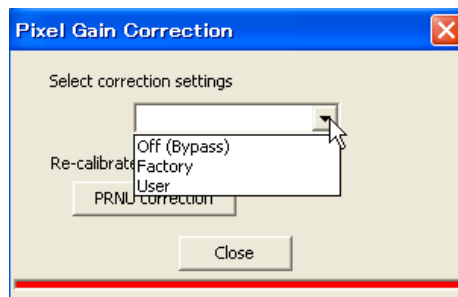
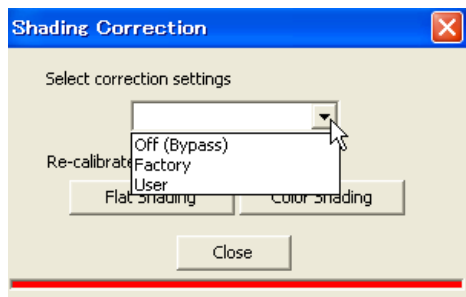

9.5.4 Help menu



Display camera software version, model name, firmware version and camera ID.



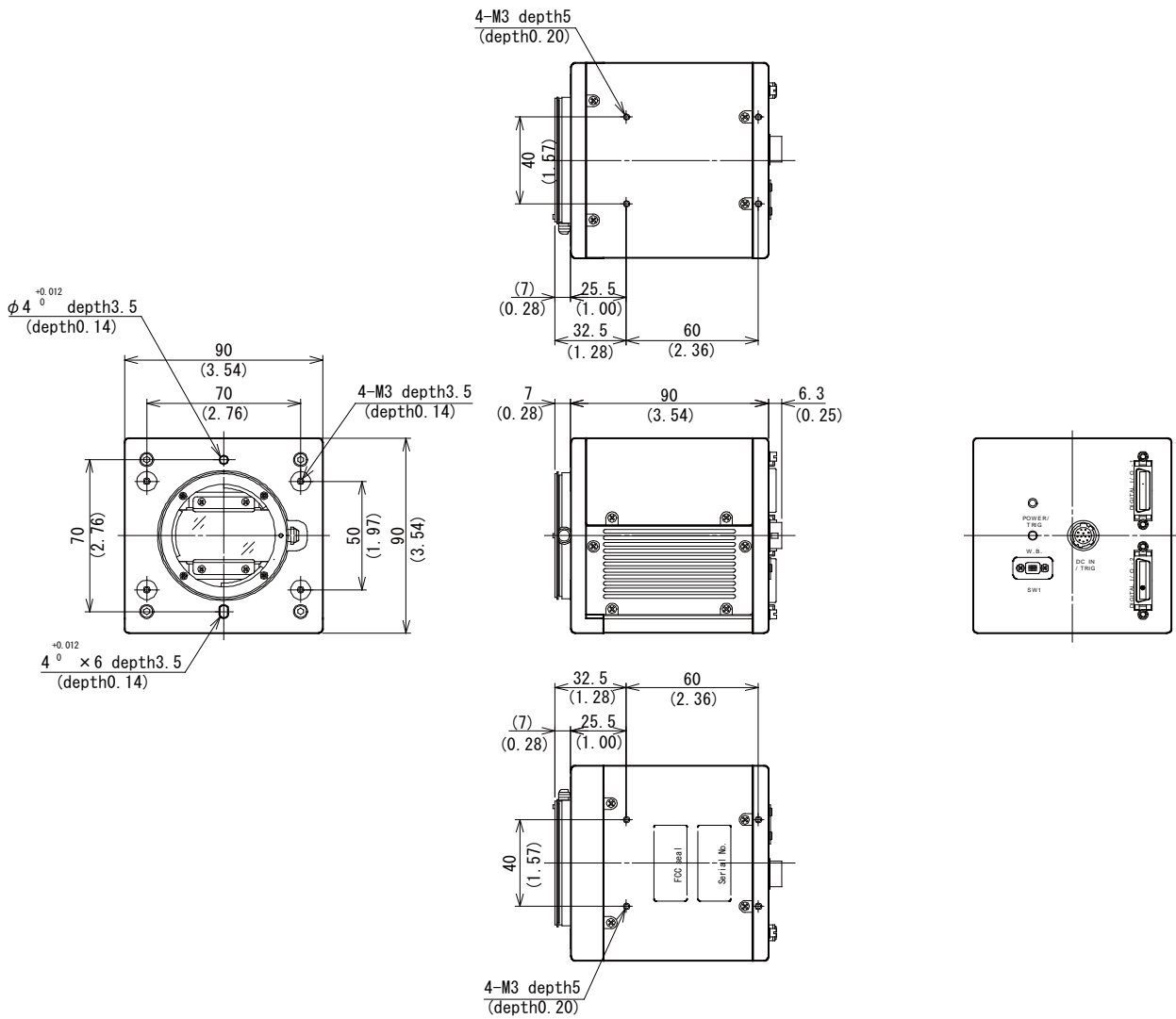

Outside size tolerance : $\pm 0.3\text{mm}$

Fig.46 External Appearance and Dimensions (Nikon F mount)

11. Specifications

11.1 Typical data

| | |
|----------------------------|--|
| Scanning system | Line Scan |
| Synchronization | Internal |
| Image Sensor | 3 prism-mounted custom CMOS sensors Effective pixels : 4096 pixels per sensor Pixel Size : 7.0 μ m \times 7.0 μ m Effective image length : 28.672 mm |
| Pixel clock | 80.00 MHz |
| Total clock | Full resolution/Binning 4944clk (Internal trigger) |
| | Sub-sampling / Windowing 2921clk (Internal trigger) |
| Line Rate | Full resolution/Binning 61.8 μ s (Internal trigger) |
| | Sub-sampling / Windowing 36.51 μ s (Internal trigger) |
| Line rate adjustable range | Adjustable range : 61.8 μ s to 15.02ms Adjustment increments : 12.5ns |
| Line frequency | Full resolution/Binning 16.18KHz (Internal trigger) |
| | Sub-sampling/Windowing 27.38KHZ (Internal trigger) |
| Sensitivity of sensor | Radiometric: 64V/(μ J / cm ²) |
| Sensitivity (Standard) | 2800 lux (7800K, Gain=Low, 0dB, Shutter =OFF, F2.8, Line rate:1100 μ s, 100% video) |
| S/N | 55dB (Green channel, Gain=0dB) |
| Video output | Digital 8-Bit x 3 or 10-Bit x 3 (Camera link) |
| Video output format | Full resolution Binning (digital accumulation) Sub-sampling Windowing |
| Gain range | ① Master tracking mode Analog Gain =Low(0dB): Master : 0dB to +8dB Red/Green/Blue : - 4dB to +14dB Analog Gain =High(+6dB): Master : 0dB to 8dB Red/Green/Blue : - 4dB to +14dB ② Individual mode Analog Gain =Low(0dB): Red/Green/Blue : - 4dB to +14dB Analog Gain =High(+6dB): Red/Green/Blue : - 4dB to +14dB |

| | |
|------------------------------------|--|
| Black level | Master tracking mode: Master(Green) : 0 to 127LSB Red/Blue : ± 64LSB (against the master value) Individual mode: Red/Green/Blue : 0 to 127LSB |
| White balance | Adjustable range : 4000K to 9000K Standard color temperature : 7800K |
| Knee control | Knee point : 0 to 1023 Knee slope: x0.000015 to x1.0000 |
| Flat field correction | PRNU within ±5% after correction (at 100% output) |
| | DSNU within ±5% after correction (at 0% output) |
| Shading correction | 1. Flat shading correction 2. Color shading correction |
| Electronic shutter | Available for Shutter-select mode Adjustable range :60µs to 14.9ms Adjustment increments : 12.5ns(1 clk) |
| Operation mode | No-shutter (Internal/External trigger) Shutter-select (Internal/External trigger) Pulse Width Control (PWC) |
| Trigger input | Hirose12-pin: 4.0±2.0Vp-p TTL or Camera Link: LVDS (CC1) Possible to change Negative Logic or Positive Logic |
| Sync output (open termination) | Camera Link LVAL, DVAL, EEN Hirose 12-pin XEEN (Negative logic) 4.0 Vp-p (no termination) |
| Test pattern gen. | Color bar, gray 1, 2 and white, 890 LSB |
| Communication interface | Via Camera Link connector or RS-232C (Hirose 12-pin connector) Baud rate: 9600bps,19200bps,38400bps,57600bps,115200bps Camera Link and Hirose 12P cannot be used at the same time. |
| Power | DC +12V-10% to +24V + 10% Typical: 450mA (No-shutter/internal, lens cap on) Max.: 480mA (No-shutter/internal, at saturation level) Note: Use a power supply with more than 3A current |
| Lens mount | LT-400CL-M52 M52 lens mount (Standard) LT-400CL-F Nikon F-Mount (Factory option) Maximum allowed rear protrusion on lenses: 13 mm |
| Flange back distance | M52 mount/Nikon F-Mount : 46.5mm tolerance: 0 ~ -0.05mm |
| Optical axis | Center ±0.1mm(Max) |
| Operating temperature /Humidity | - 5°C to +45°C / 20 to 80% (non-condensing) |
| Storage temperature | -25°C to +60°C, 20 to 80% (non-condensing) |

LT-400CL

| | |
|------------|---|
| /humidity | |
| Vibration | 3G (20Hz to 200Hz XYZ direction) |
| Shock | 50G |
| Regulation | CISPR Pub.22 (EN55022)(Emission), CISPR Pub.24(Immunity) IEC61000-4-2 Conforming to Level 4 (Note 1) FCC Part15 Class B, RoHS |
| Dimensions | 90(W) x 90(H) x 90(D) mm (without connector and lens mount protrusion) |
| Weight | 830 g |
| Connectors | Camera Link: 110226-1A10PL x2 Hirose 12-Pin: HR10A-10R-12PB(71) |

Note1: This specification can be satisfied when the recommended connector and cable are used.

Note2: The above specifications are subject to change without notice.

11.2 Spectral sensitivity

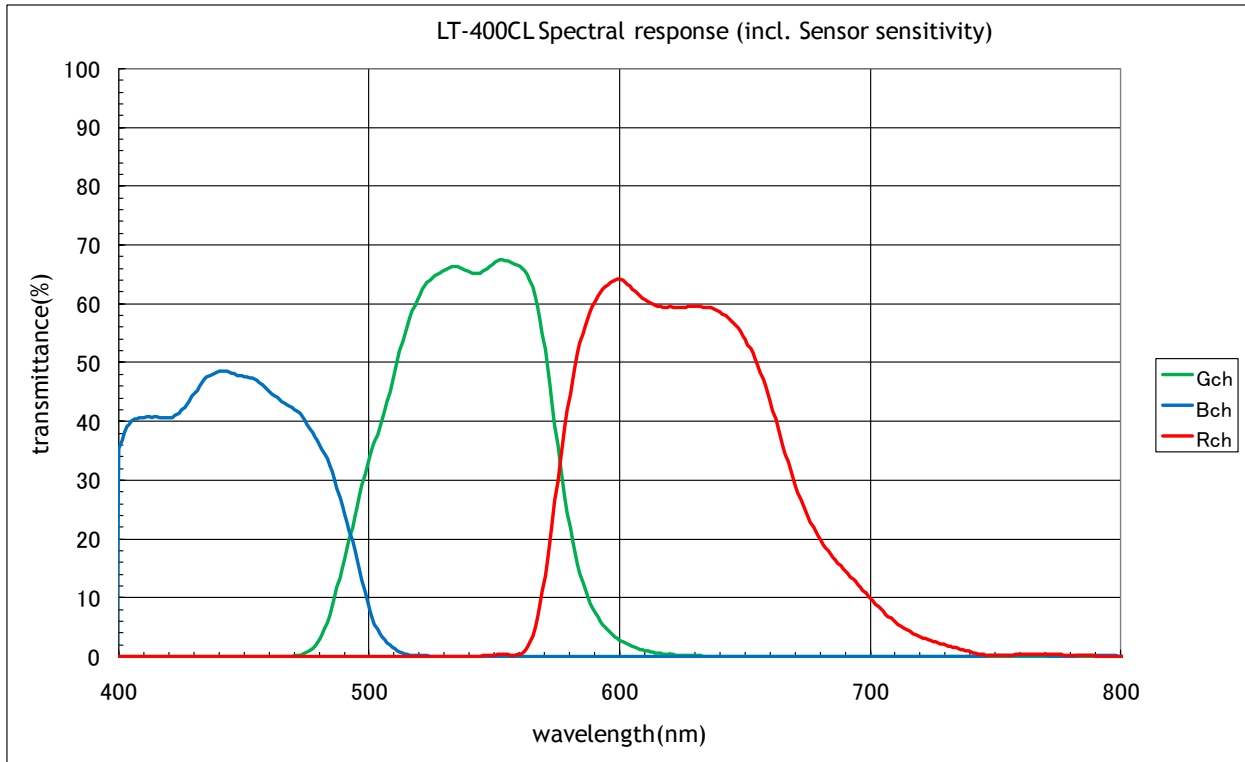

Fig.34 Spectral response including prism and sensors

Appendix

1. Precautions

Personnel not trained in dealing with similar electronic devices should not service this camera. The camera contains components sensitive to electrostatic discharge. The handling of these devices should follow the requirements of electrostatic sensitive components.

Do not attempt to disassemble this camera.

Do not expose this camera to rain or moisture.

Do not face this camera towards the sun, extreme bright light or light reflecting objects.

When this camera is not in use, put the supplied protective cap on the lens mount.

Handle this camera with the maximum care.

Operate this camera only from the type of power source indicated on the camera.

Remove power from the camera when changing switch settings.

2. Typical Sensor Characteristics

The image sensors used in the LT-400CL are CMOS type and have been chosen for their superior performance. There may, however, always be artifacts visible in the scanned image originating from pixel imperfections in the camera. The Pixel Gain and Pixel Black correction functions will allow the user to compensate for such artifacts, producing an essentially “flat” image.

3. Caution when mounting a lens on the camera

When mounting a lens on the camera dust particles in the air may settle on the surface of the lens or the image sensor of the camera. It is therefore important to keep the protective caps on the lens and on the camera until the lens is mounted. Point the lens mount of the camera downward to prevent dust particles from landing on the optical surfaces of the camera. This work should be done in a dust free environment. Do not touch any of the optical surfaces of the camera or the lens.

4. Caution when mounting the camera

When you mount the camera on your system, please make sure to use screws of the recommended length described in the following drawing. Longer screws may cause serious damage to the PCB inside the camera.

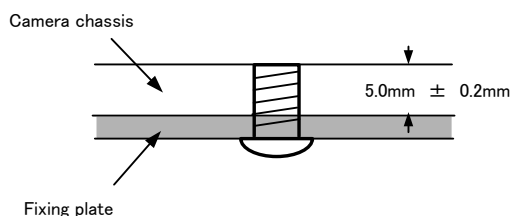

Mounting the camera to fixing plate

If you mount the tripod mounting plate, please use the provided screws.

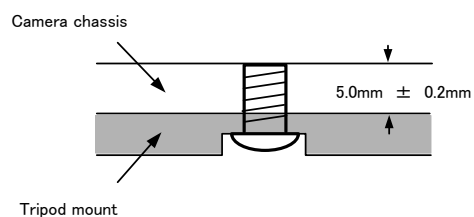

Attaching the tripod mount

5. Exportation

When exporting this product, please follow the export regulation of your own country.

6. References

1. This manual for LT-400CL can be downloaded from www.jai.com
2. Datasheet for LT-400CL can be downloaded from www.jai.com
3. The camera control software can be downloaded from www.jai.com



User's Record

Camera type: **LT-400CL**
Revision:
Serial No.
Firmware version.

For camera revision history, please contact your local JAI distributor.

User's Mode Settings.

User's Modifications.

Company and product names mentioned in this manual are trademarks or registered trademarks of their respective owners. JAI A-S cannot be held responsible for any technical or typographical errors and reserves the right to make changes to products and documentation without prior notification.

| | | |
|---|-----------------------|-----------------------------------|
| Europe, Middle East & Africa | Asia Pacific | Americas |
| Phone +45 4457 8888 | Phone +81 45 440 0154 | Phone (toll-free) +1 800 445 5444 |
| Fax +45 4491 3252 | Fax +81 45 440 0166 | Phone +1 408 383 0300 |

Visit our web site at www.jai.com



See the possibilities