

Z series | IR IP dome

ZR2322 Auto Focus Recessed IR IP Dome

www.meritlilin.com



<p>2-way audio</p>	<p>Easy to Install</p>
<p>Infrared</p>	<p>IP based</p>
<p>SD card recording</p>	<p>Day/Night operations</p>

Full HD
1080

ONVIF S

- ▶ Stylish recessed dome
- ▶ Powerful Auto Focus feature
- ▶ Surface/recessed mount conversion kit supplied
- ▶ Motion, tamper, alarm detection
- ▶ 25-metre infrared night vision
- ▶ 1080p resolution

Dimensions: Ø 150 x 134mm

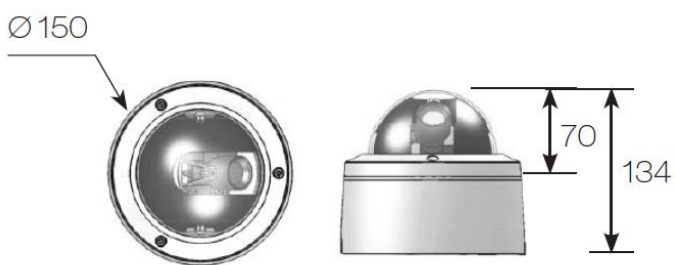
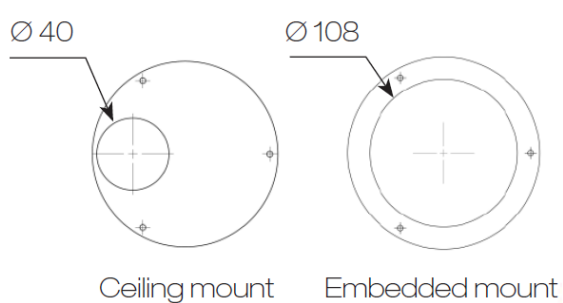

Diagram of mounting holes: (unit: mm)



An ideal solution for places that discreet surveillance is required

ZR2322 features an embedded mount as well as ceiling mount installations in response to a diverse array of environments for total situational awareness. The camera has built-in IR illuminator providing clear vision at night and Auto Focus feature to automatically focus the camera from a distant location. With motorized lens, all you need to do with zoom/focus adjustments is simply a click on browsers. The visible part of the camera housing extends only 7mm in below the ceiling, giving the housing a low-profile look. The dome is a hemisphere form which is constructed of distortion free for outstanding image quality. When motion triggers cameras, you will receive email alerts at the first sign of trouble. Support with PoE, privacy mask, 3D noise reduction, 2D WDR function, and minimum illumination 0.02 lux at F1.4 low light mode. ZR2322 recessed dome camera is an ideal solution for public environments where discreet surveillance is needed

Built-in IR Illumination

ZR2322 IP camera with infrared (IR) illumination where IR LEDs are built-in. Built-in with IR LED, the camera provides night vision up to 25 metres

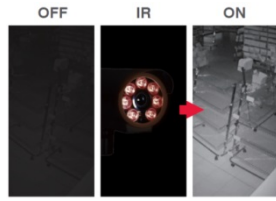

Video Security App

Available on Android and iOS – **LILINViewer** app provides security alarm push notification, real-time live viewing, and remote video playback



SD Cards in Sync with NAV Software

ZR2322 camera with built-in Micro SD/SDHC card slots can provide redundant video viewing and recording. You can synchronize an SD card with LILIN VMS (Video Management Software) – Navigator (NAV)



3D Noise Reduction

Remove noise from a signal. Suppressing noise in an image in low light conditions and able to retain quality videos at the same time



Region of Interest (ROI)

A Region of Interest (ROI) is a specified part of an image that is highlighted from a camera. This feature is great for highlighting areas such as doors or areas of access where an overall scene is still required

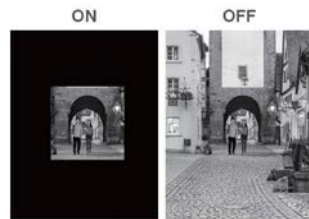

ONVIF-compliant

Open Network Video Interface Forum (ONVIF) is a standard for physical IP based security products. ZR2322 camera is ONVIF Profile S conformant



Alarm Detection

Alarm Detection is designed to provide the electronic detection of intruders



Motion Detection

Detect motion and capture the event. Motion in the selected area will provoke an alert.



Auto Focus feature

Use the camera software to trigger the auto focus function at any time during installation or after. Auto Focus feature to automatically focus the camera from a distant location, which eases the process on installation and helps you effectively position the camera at the right focus angle in a matter of seconds



Day and Night Operations via Removal of the IR-cut filter

ZR2322 camera was designed using a mechanical IR cut filter for increased IR sensitivity resulting in improved night time images. The removable IR-cut filter allows day and night operations even in the low lux condition providing outstanding vision



Sense Up+

Deliver outstanding video outputs in poor light conditions without experiencing motion blur. You can see video clearly even during nighttime without sufficient lighting support



Wide Dynamic Range (WDR)

Wide Dynamic Range (WDR) displays details of both the brightest and darkest areas. WDR can extend image visibility under high contrast lighting scenes and improve image quality

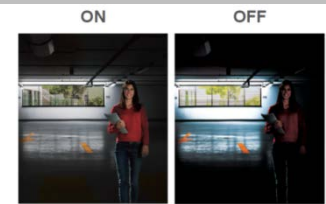

Privacy Masking

Privacy Masking is a feature used to protect personal privacy by concealing private areas in the camera's field of view. Doorways and house windows for example are not subject to surveillance

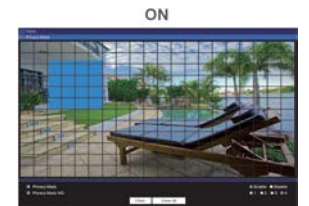

Audio Detection

With Audio Detection technology, an alarm is triggered based on ambient sound conditions as the threshold



Face Detection

Automatically detects a human face



Tamper Detection

Automatically detects camera sabotage or failure. Detects any attempts to tamper with the camera – partially or completely blocking its lens or field of view

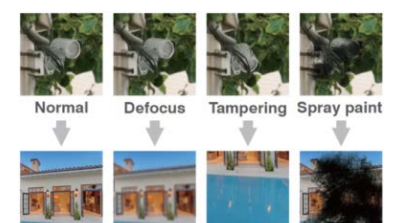

Auto Focus Recessed IR IP Dome

Video performance

Model#	ZR2322EX3
Low Light Mode (Colour)	0.02 lux at F1.4
With Infrared	0.0 lux
2D WDR	Off / Auto / x2 / x3/ x4 (by normal mode)

Power

Power consumption	DC12V, 10W / PoE, 11.2W
PoE	IEEE802.3af
Power supply	DC12V ±10% Power over Ethernet (IEEE 802.3af compliant)

Sensor

Sensor type	1/2.8" CMOS image sensor
Total sensor pixels	1984 (H) x 1105 (V) = 2,192,320 pixels

Certifications

CE	EN 55022: 2010 Class A IEC 61000-3-2: 2005+A1: 2008+A2: 2009 IEC 61000-3-3: 2008
FCC	FCC Part 15: Subpart B (10-1-10 Edition) Class A CISPR 22: 2008 Class A

Lens

Focal length	2.8~12 mm (zoom / focus motorized)
Iris	F1.4
Angle of View	H 91.2° ~ 25.5° V 68.4° ~ 19.1° D 114° ~ 31.9°

Night vision (infrared LED)

Distance	25m
Peak wavelength	850nm, high efficiency array
Beam spread	30°

Environmental

Operating temperature	-25°C to +50°C (-13°F to 122°F)
-----------------------	---------------------------------

PC requirement

CPU	Intel Pentium 4 1.8GHz or above
OS	Windows 2000, Windows XP, Windows Vista, Windows 7, Windows 8
RAM	1GB or above, Independent Display Card

Mechanical

Dimensions	Ø 150 x 134mm
Weight	640g approx.

Input / output

Audio input / output	Mono, 1.4 Vp-p, 50 KΩ, 3.5mm phone jack
Alarm input / output	Digital 1 input (TTL, +3 ~ 5VDC) / 1 Output (MOS Relay contact N.O., Load max. 40VDC/300mA)
Live video output	CVBS 1.0Vp-p, 75 ohm, RCA connector

Network security

User accounts	10 users accounts available
Access	Multiple user access levels with password protection
Encryption	Base 64 HTTP encryption

Video streaming

Video compression	H.264, Motion JPEG
Streaming	RTP/HTTP, RTP/TCP, RTP/UDP, Multicast Multiple configurable streams in H.264 and M-JPEG, configurable frame rate and bandwidth
Bitrate	128Kbps to 8Mbps Frame rate and bitrate controllable on-the-fly VBR / CBR / GOP supported
IP filter	Yes
RTSP Authentication	On / Off

Video resolution (H x V)

1080p HD	1920 x 1080	
720p HD	1280 x 720	
D1	720 x 480	
CIF	352 x 240	
Multiple profile	Profile #1	H.264 : up to 30 FPS @ 1920 x 1080, MJPEG : up to 30 FPS @ 720 x 480
	Profile #2	H.264 : up to 30 FPS @ 1280 x 720, MJPEG : up to 30 FPS @ 352 x 240
	Profile #3	H.264 : up to 30 FPS @ 1920 x 1080, MJPEG : up to 30 FPS @ 1280 x 720
	Profile #4	H.264 : up to 30 FPS @ 720 x 480, MJPEG : up to 15 FPS @ 1920 x 1080

Video functions

Day/Night (IR-cut filter)	Colour (Day), Monochrome (Night), Auto, Schedule
Scanning system	Progressive scan
Auto Focus	One push
Adjustable picture setting	Contrast, Brightness, Saturation
White balance	Auto / Tungsten / Indoor / Fluorescents1 / Fluorescents2 / Outdoor1 / Outdoor2
Shutter	1/30(1/25)s to 1/8000s
Back light compensation	On / Off
3D noise reduction	Off / 1 to 32 selectable
Privacy masking	Four independent areas
Sense Up	Off / 1 frame / 2 frames / 3 frames / 7 frames
Sense Up+	Yes
Auto gain control	36 dB variable gain
Other functions	Sharpness, Image flip, Image mirror, Defog, Hue
D/N quality setting	Yes

Integration

Mobile application	Integrated to LILIN mobile app (LILINViewer) iPhone, iPad, Android support
Video management	ONVIF Profile S LILIN NAV 1.0 Third party VMS through LILIN HTTP API
SD card recording	Support Micro SD/SDHC card for circular recording (card is not included)
Web browser	Microsoft® Internet Explorer® 6.0 and later
Firmware	Firmware upgrade via HTTP
Alarm functions	Face / tampering / audio / motion / alarm detection
Alarm event	FTP,SMTP, HTTP post, SD card, SAMBA
Alarm weighted mode	Yes

Network

Ethernet	10Mbps / 100Mbps Base-T, RJ-45
Connectivity	ONVIF Profile S
Users	8 simultaneous users
ePTZ & digital zoom	Yes, ROI (Region of Interest) is supported
OSD	Text overlay for date, time and camera name
CPU, Memory	Embedded SoC ARM11, 528MHz, 256MB DDR2, 256MB flash memory
Video display	LILIN Universal ActiveX & LILIN Java Applet
OS	Embedded Linux 2.6.32
2-way audio	G.711 / PCM
Protocols	IPv4, IPv6, TCP, UDP, HTTP, SMTP, NTP, DDNS, UPnP, FTP, ARP, DHCP, PPPoE, DNS, RTSP, RTCP, Telnet, ICMP, IGMP, ONVIF Profile S, SNMP, SIP, Bonjour
Multi IP address	Yes